

## INDEX

SUPPLEMENTARY OUTRIGGERS	PAGE
60801F - 61801F/CE	6
60802ME - 60802ME/CE - 60803ME/CE	7
210801F	8
210802ME - 210802ME/CE	9
210803ME - 210803ME/CE	10
211801F/CE	11
215800HE - 215800HE/CE - 215800HS/CE	12
290800HE - 290800HE/CE - 290800HS/CE	13
330802HE - 330802HE/CE - 330802HS/CE	14
391800HE	15
415800HE - 415800HE/CE - 415800HS/CE	16
415802HE - 415802HE/CE - 415802HS/CE	17
541800HE - 541800HE/CE - 541800HS/CE	18
700802HE - 700802HE/CE - 700802HS/CE	19
752801HE - 752801HE/CE - 752801HS/CE	20
752802HE - 752802HE/CE - 752802HS/CE	21
1150A140 - 1150A140/CE - 1150A140S/CE	22
1400A140 - 1400A140/CE - 1400A140S/CE	23
1400A203 - 1400A203/CE	24
1400A303 - 1400A303/CE	25
1400A313 - 1400A313/CE	26
1950A203/CE	27



	61801F	608023ME	210801F	210802ME	210803ME	211801F	211800HE(HS)	290800HE(HS)	330802HE(HS)	391600HE	413800HE(HS)	415802HE(HS)	541800HE(HS)	708002HE(HS)	752801HE(HS)	752802HE(HS)	11504140(S)	14004140(S)	1400A203	1400A303	1400A313	1950A203		
F26A.0 active	•	•																						
F30C.Y0 active	•	•																						
F32A.0 active	•	•																						
F40B.0 active	•	•																						
F50A.0 active / e-active	•	•																						
F55A.0 e-active	•	•																						
F65B.0 active / e-active	•	•																						
F65B.1 dynamic / e-dynamic	•	•																						
F70B.0 e-active	•	•																						
F70B.1 e-dynamic	•	•																						
F85B.0 active / e-active	•	•																						
F85B.1 dynamic / e-dynamic	•	•	•	•	•	•	•																	
F85B.2 dynamic / e-dynamic	•	•	•	•	•	•	•																	
F90B.0 e-active	•	•																						
F90B.1 e-dynamic	•	•																						
F95A.0 active / e-active	•	•																						
F100B.1 xe-dynamic	•	•	•	•	•	•	•																	
F100B.2 xe-dynamic	•	•	•	•	•	•	•																	
F105A.0 e-active			•	•	•	•	•																	
F110B.0 active / e-active			•	•	•	•	•	•																
F110B.1 dynamic / e-dynamic			•	•	•	•	•	•																
F110B.2 dynamic / e-dynamic			•	•	•	•	•	•																
F20B.0 e-active			•	•	•	•	•	•																
F20B.1 e-dynamic			•	•	•	•	•	•																
F20B.2 e-dynamic			•	•	•	•	•	•																
F25A.1 xe-dynamic			•	•	•	•	•	•																
F25A.2 xe-dynamic			•	•	•	•	•	•																
F35A.0 active / e-active			•	•	•	•	•	•																
F35A.2 dynamic / e-dynamic			•	•	•	•	•	•																
S serie			•	•	•	•	•	•																
F155A.0 active / e-active			•	•	•	•	•	•																
F155A.2 dynamic / e-dynamic			•	•	•	•	•	•																
F165A.0 e-active			•	•	•	•	•	•																
F165A.2 e-dynamic			•	•	•	•	•	•																
F175A.0 active / e-active			•	•	•	•	•	•																
F175A.2 dynamic / e-dynamic			•	•	•	•	•	•																
F185A.2 xe-dynamic			•	•	•	•	•	•																
F195A.0 active / e-active			•	•	•	•	•	•																
F195A.2 dynamic / e-dynamic			•	•	•	•	•	•																
F215A.0 active / e-active			•	•	•	•	•	•																
F215A.2 dynamic / e-dynamic			•	•	•	•	•	•																
F255A.0 e-active			•	•	•	•	•	•																
F255A.2 e-dynamic			•	•	•	•	•	•																
F245A.0 active / e-active			•	•	•	•	•	•																
F245A.2 e-dynamic			•	•	•	•	•	•																
F255A.2 xe-dynamic			•	•	•	•	•	•																

	61801F	608023ME	210801F	210802ME	210803ME	211801F	215800HE(HS)	290800HE(HS)	330802HE(HS)	391900HE	415800HE(HS)	415802HE(HS)	541800HE(HS)	700802HE(HS)	732801HE(HS)	752802HE(HS)	1150A140(S)	1400A140(S)	1400A203	1400A303	1400A313	1950A203	
F275A.0 e-active																							
F275A.2 e-dynamic																							
F295A.2 e-dynamic																							
F295RA.2 e-dynamic																							
F305A.2 xe-dynamic																							
F315A.2 e-dynamic																							
F315RA.2 e-dynamic																							
F335A.2 e-dynamic																							
F335RA.2 e-dynamic																							
F345A.2 xe-dynamic																							
F345RA.2 xe-dynamic																							
F365A.2 e-dynamic																							
F365RA.2 e-dynamic																							
F385A.2 e-dynamic																							
F385RA.2 e-dynamic																							
F390SE																							
F395A.2 xe-dynamic																							
F395RA.2 xe-dynamic																							
F415A.2 e-dynamic																							
F415RA.2 e-dynamic																							
F425A.2 e-dynamic																							
F425RA.2 e-dynamic																							
F455A.2 e-dynamic																							
F455RA.2 e-dynamic																							
F485A.2 xe-dynamic																							
F485RA.2 xe-dynamic																							
F515RA.2 e-dynamic																							
F545RA.2 xe-dynamic																							
F600RA.2 lie-dynamic																							
F660RA.2 lie-dynamic																							
F710RA.2 xlie-dynamic																							
F720RA.2 lie-dynamic																							
F800RA.2 lie-dynamic																							
F820RA.2 xlie-dynamic																							
F950RA.2 lie-dynamic																							
F990RA.2 xlie-dynamic																							
F1150RA.2 xlie-dynamic																							
F1300RA.2 lie-dynamic																							
F1350RA.2 xlie-dynamic																							
F1600RA.2 lie-dynamic																							
F1600RAL.2 lie-dynamic																							
F1650RAL.2 xlie-dynamic																							
F1650RA.2 lie-dynamic																							
F1950RAL.2 lie-dynamic																							
F2150RA.2 xlie-dynamic																							
F2150RAL.2 xlie-dynamic																							

## 60801F - 61801F/CE

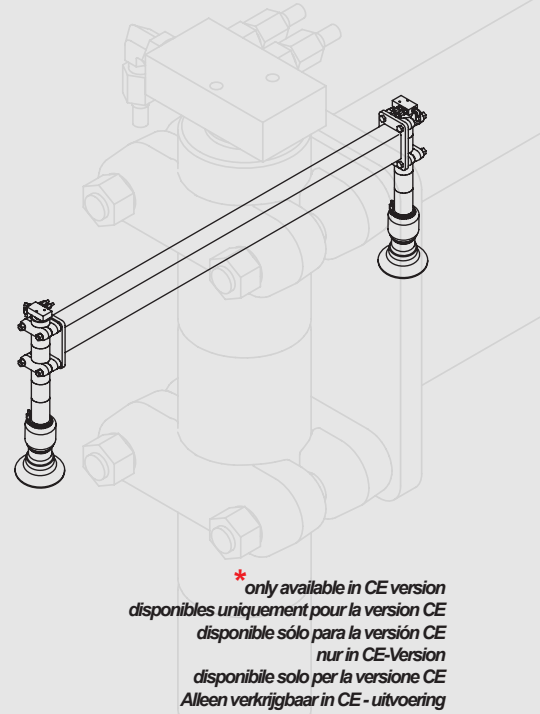
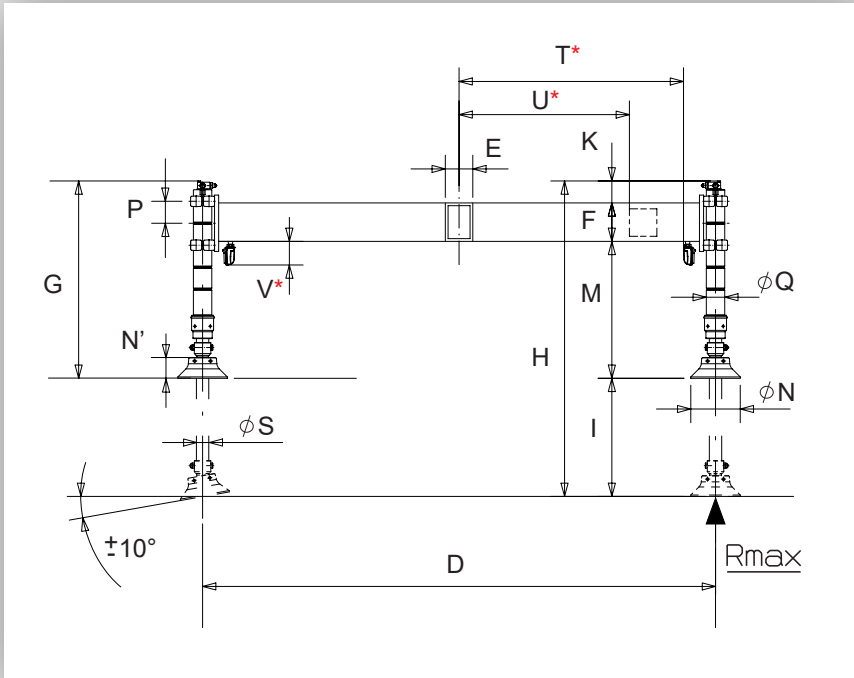

OPTIONS	D	E	F	G	H	I	K	M	N Ø	N'	Q Ø	S Ø	P	T*	U*	V*	
	1867	90	115	719	1149	430	97 257	507 347	180	75	67 55	45	2x80	817	620	80	68 - 75*
<b>L</b>	1867	90	115	849	1409	560	67 387	667 347	180	75	67 55	45	2x80	817	620	80	74 - 81*

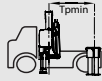

F26A.0 - F40B.0

2000 mm

1580 daN

F50A.0 - F55A.0

2500 mm

F65B.0 - F70B.0

3000 mm

F65B.1 - F70B.1

3000 mm

F85B.0 - F90B.0

3500 mm

F85B.1 - F90B.1 - F100B.1

3500 mm

F85B.2 - F90B.2 - F100B.2

3500 mm



### SUPPLEMENTARY OUTRIGGERS

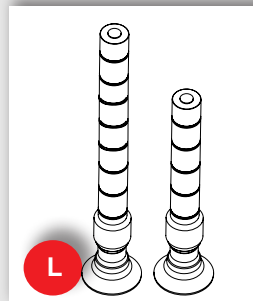
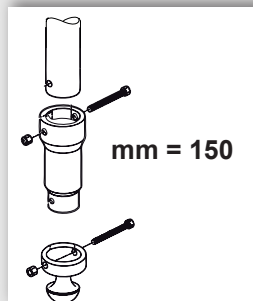
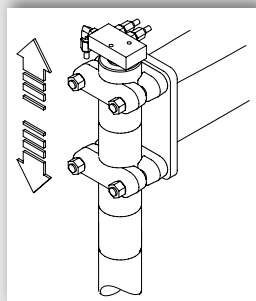

**L**

optional

## 60802ME - 60802ME/CE - 60803ME/CE

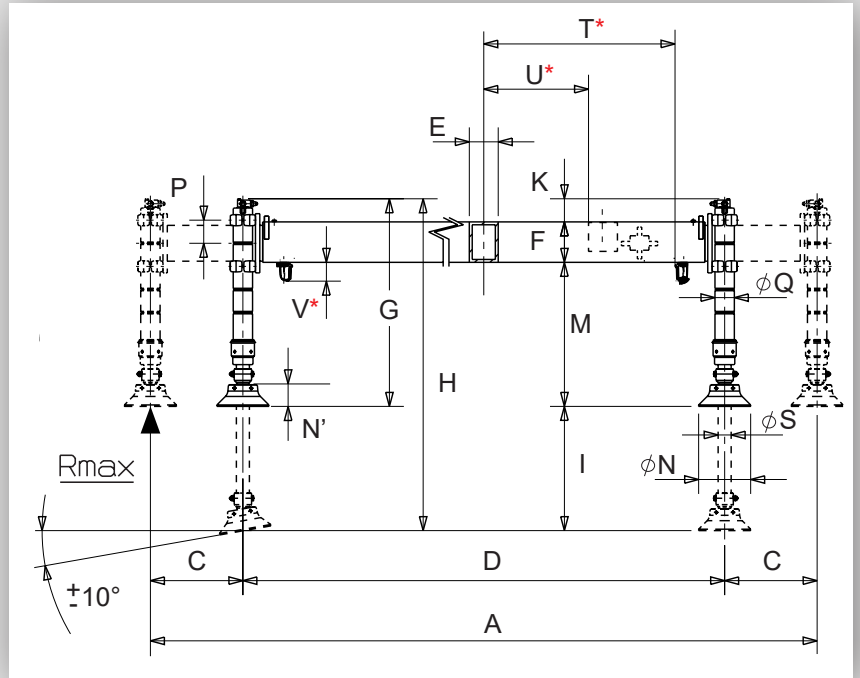
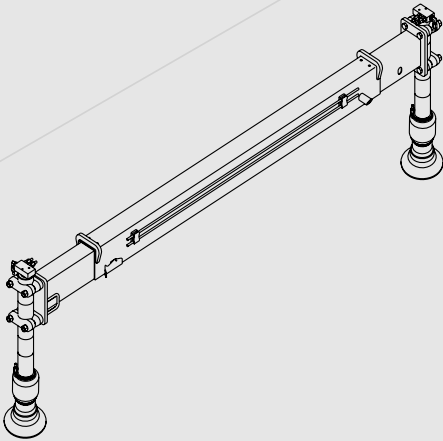

\* only available in CE version  
 disponibles uniquement pour la version CE  
 disponible sólo para la versión CE  
 nur in CE-Version  
 disponibile solo per la versione CE  
 Alleen verkrijgbaar in CE-uitvoering

OPTIONS	A	C	D	E	F	G	H	I	K	M	N Ø	N'	Q Ø	S Ø	P	T*	U*	V*	
	2507	320	1867	100	140	718	1148	430	80 240	498 338	180	75	67 55	45	2x80	760	463	65	85
<b>L</b>	2507	320	1867	100	140	848	1408	560	50 370	658 338	180	75	67 55	45	2x80	760	463	65	91

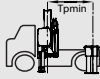

F26A.0 - F40B.0	2000 mm
F50A.0 - F55A.0	2500 mm
F65B.0 - F70B.0	2750 mm
F65B.1 - F70B.1	2750 mm
F85B.0 - F90B.0	3600 mm
F85B.1 - F90B.1 - F100B.1	3600 mm
F85B.2 - F90B.2 - F100B.2	3600 mm

1380 daN

### SUPPLEMENTARY OUTRIGGERS

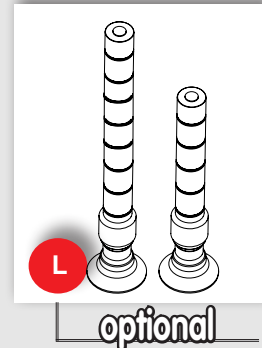
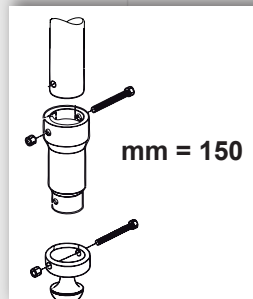
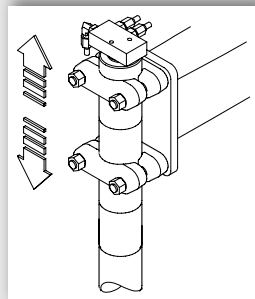
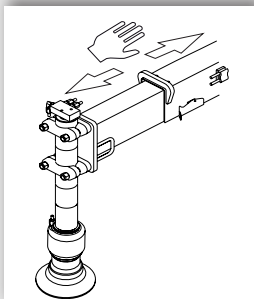

## 210801F

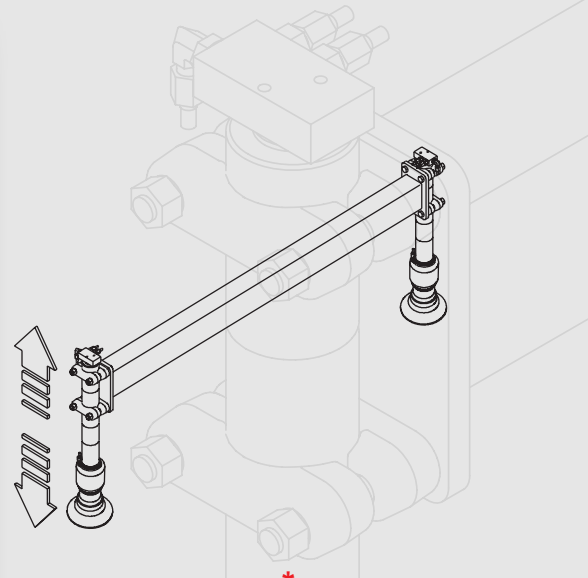
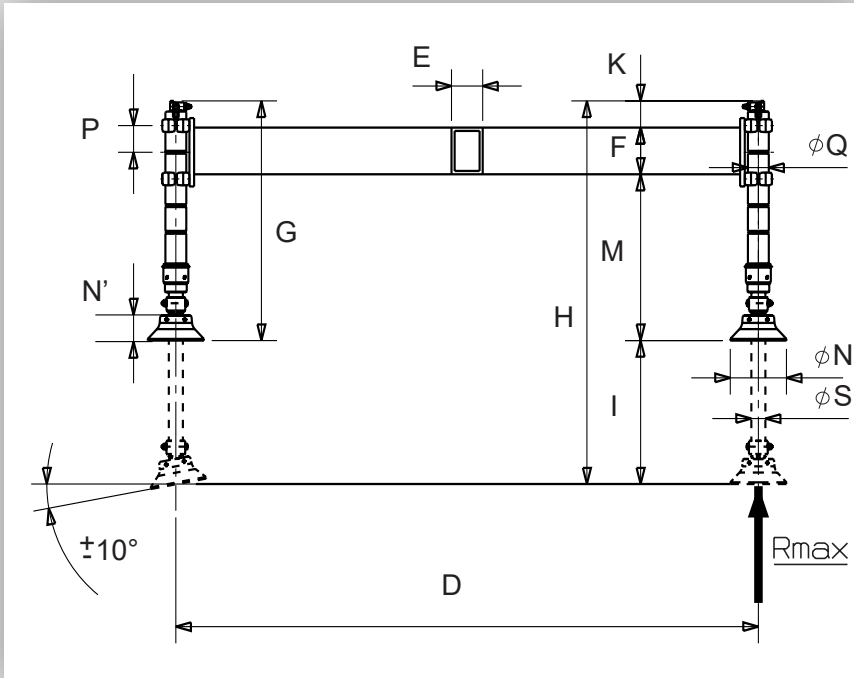

\* only available in CE version  
 disponibles uniquement pour la version CE  
 disponible sólo para la versión CE  
 nur in CE-Version  
 disponibile solo per la versione CE  
 Alleen verkrijgbaar in CE - uitvoering

OPTIONS	D	E	F	G	H	I	K	M	φN	N'	φQ	φS	P	
	2137	105	150	780	1235	455	132	498	180	75	87	60	2x97	116
<b>R</b>	2377	105	150	780	1235	455	327	303	180	75	75	60	2x97	149
<b>R L</b>	2377	105	150	820	1380	560	102	633	180	75	87	60	3x97	156
<b>L</b>	2137	105	150	820	1380	560	394	342	180	75	75	60	3x97	123

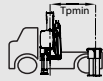

F85B.1 - F165A.2 / F185A.2	3000 mm	3300 mm
F175A.0 - F195A.2	3700 mm	4000 mm
F215A.0 - F235A.2 / F255A.2	4000 mm	4200 mm
F145AS - F160ASXP	3500 mm	
F195AS - F210ASXP	4000 mm	
F215AS - F240ASXP	4500 mm	

Rmax std	4210 daN
Rmax rot	3490 daN



### SUPPLEMENTARY OUTRIGGERS

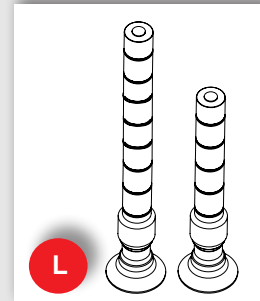
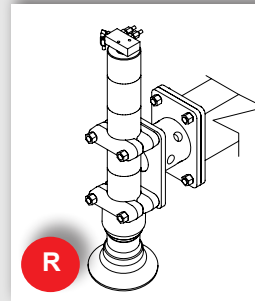
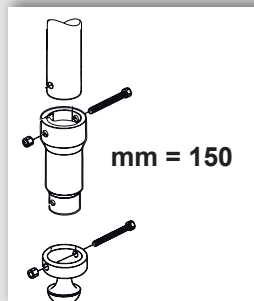
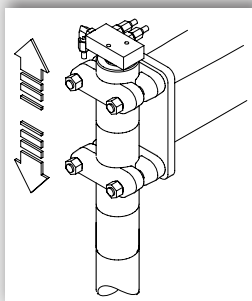

optional



## 210802ME - 210802ME/CE

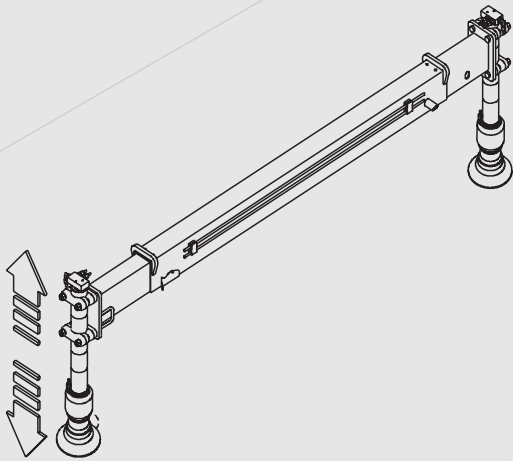

\* only available in CE version  
 disponibles uniquement pour la version CE  
 disponible sólo para la versión CE  
 nur in CE-Version  
 disponibile solo per la versione CE  
 Alleen verkrijgbaar in CE - uitvoering

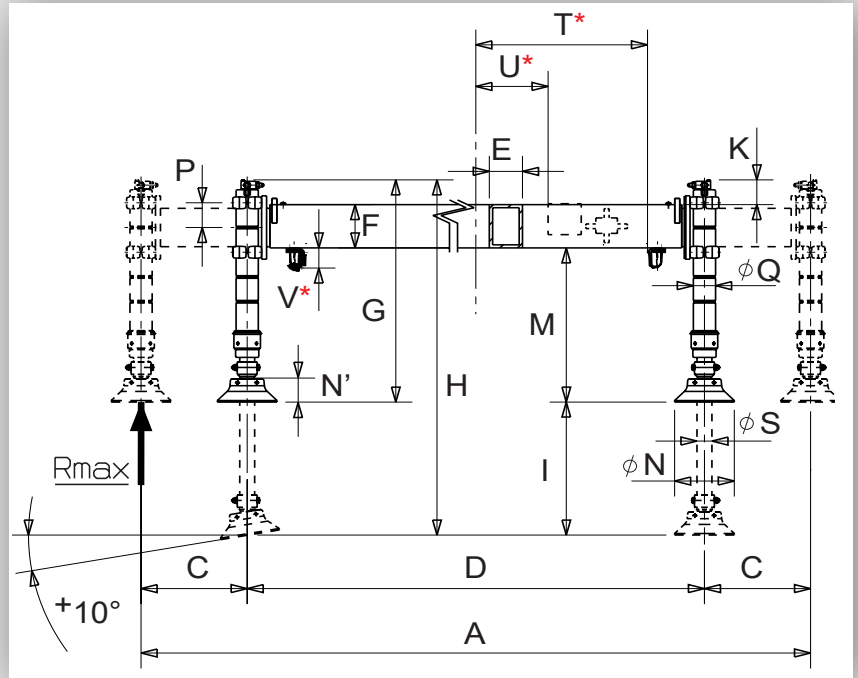

OPTIONS	A	C	D	E	F	G	H	I	K	M	φN	N'	φQ	φS	P	T*	U*	V*	
	3563	700	2163	122	177	780	1235	455	116 311	487 292	180	75	87 75	60	2x97	830	597	65	165
<b>R</b>	3853	700	2453	122	177	780	1235	455	116 311	487 292	180	75	87 75	60	2x97	830	597	65	198
<b>R L</b>	3853	700	2453	122	177	885	1445	560	85 378	622 330	180	75	87 75	60	3x97	830	597	65	205
<b>L</b>	3563	700	2163	122	177	885	1445	560	85 378	622 330	180	75	87 75	60	3x97	830	597	65	173

Model	Dimensions	Capacity
F85B.1 - F90B.1 - F100B.1	3000 mm / 3300 mm	3430 daN
F85B.2 - F90B.2 - F100B.2	3000 mm / 3300 mm	3100 daN
F95A.0 - F105A.0	3000 mm / 3000 mm	3430 daN
F110B.0 - F125A.2	3000 mm / 3000 mm	3100 daN
F135A.0 - F165A.2 / F185A.2	3200 mm / 3200 mm	3430 daN
F175A.0	3500 mm / 3500 mm	3100 daN
F175A.2 - F195A.2	4000 mm / 4000 mm	3430 daN
F215A.0 - F235A.2 / F255A.2	4200 mm / 4200 mm	3100 daN

### SUPPLEMENTARY OUTRIGGERS

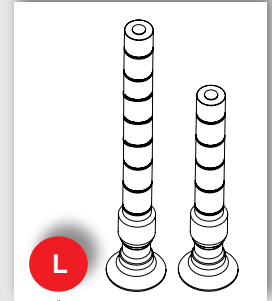
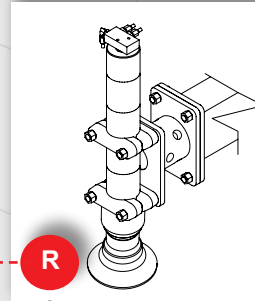
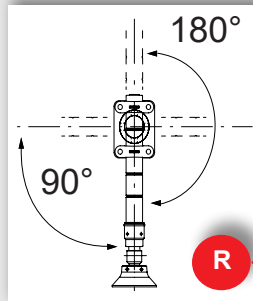
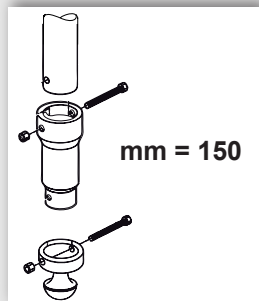
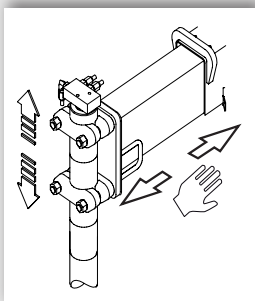

optional

## 210803ME - 210803ME/CE

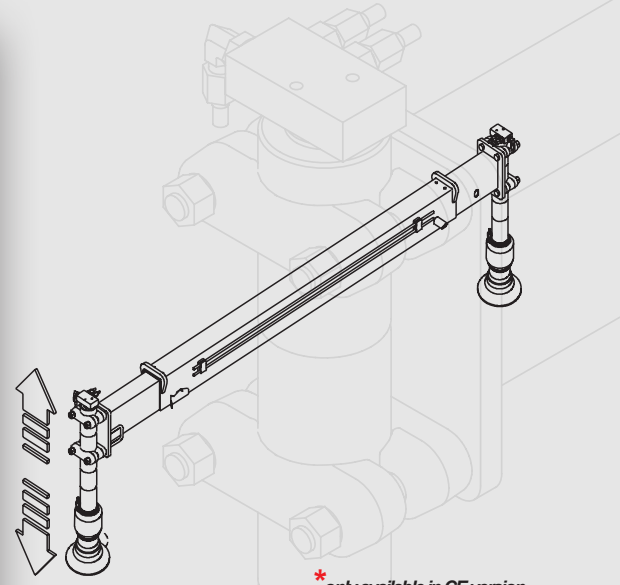
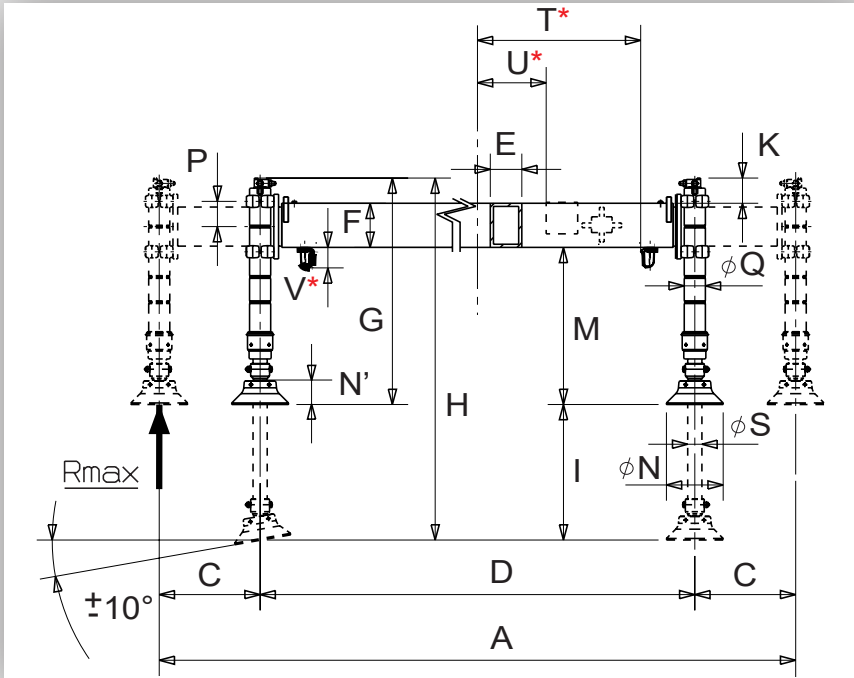

\* only available in CE version  
 disponibles uniquement pour la version CE  
 disponible sólo para la versión CE  
 nur in CE-Version  
 disponibile solo per la versione CE  
 Alleen verkrijgbaar in CE - uitvoering

OPTIONS	A	C	D	E	F	G	H	I	K	M	φN	N'	φQ	φS	P	T*	U*	V*	
	3103	535	2033	122	167	780	1235	455	120 315	492 297	180	75	87 75	60	2x97	900	532	65	156
<b>R</b>	3393	535	2323	122	167	780	1235	455	120 315	492 297	180	75	87 75	60	2x97	900	532	65	190
<b>R L</b>	3393	535	2323	122	167	885	1445	560	85 378	627 334	180	75	87 75	60	3x97	900	532	65	196
<b>L</b>	3103	535	2033	122	167	885	1445	560	85 378	627 334	180	75	87 75	60	3x97	900	532	65	163

Icon	Icon	Icon	Icon	Icon	Icon	Icon	Icon	Icon	Icon	Icon	Icon	Icon	Icon	Icon	Icon	Icon	Icon	Icon	Icon
F85B.1 - F90B.1 - F100B.1	3000 mm	3300 mm	F145AS - F160ASXP	3500 mm	Rmax std	Rmax rot	3770 daN	3360 daN											
F85B.2 - F90B.2 - F100B.2	3000 mm	3300 mm	F195AS - F210ASXP	4000 mm															
F95A.0 - F105A.0	3000 mm	3000 mm	F215AS - F240ASXP	4500 mm															
F110B.0 - F125A.2	3000 mm	3000 mm																	
F135A.0 - F165A.2 / F185A.2	3200 mm	3200 mm																	
F175A.0 - F175A.2 - F195A.0	3500 mm	3500 mm																	
F195A.2	4000 mm	4000 mm																	
F215A.0 - F235A.2 / F255A.2	4200 mm	4000 mm																	

### SUPPLEMENTARY OUTRIGGERS

mm = 150

90° 180°

**R**

**L**

optional

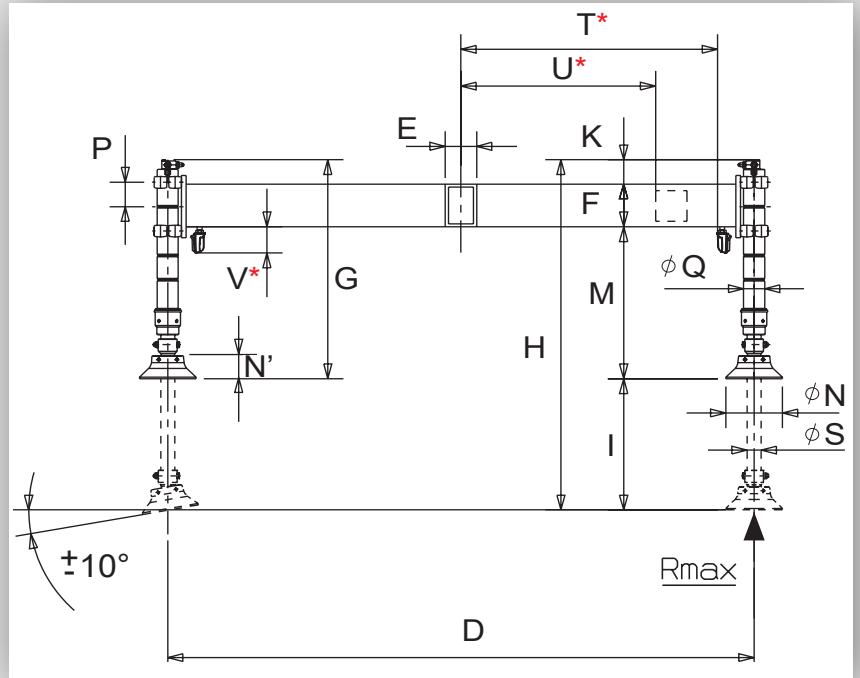
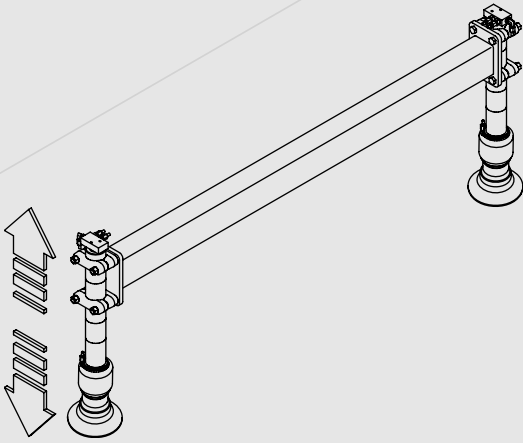

\* only available in CE version  
 disponibles uniquement pour la version CE  
 disponible sólo para la versión CE  
 nur in CE-Version  
 disponibile solo per la versione CE  
 Alleen verkrijgbaar in CE - uitvoering

OPTIONS	D	E	F	G	H	I	K	M	φN	N'	φQ	φS	P	T*	U*	V*	
	2137	105	150	780	1235	455	132 327	498 303	180	75	87 75	60	2x97	817	620	80	126
<b>R</b>	2427	105	150	780	1235	455	132 327	498 303	180	75	87 75	60	2x97	817	620	80	159
<b>R L</b>	2427	105	150	820	1380	560	102 394	633 342	180	75	87 75	60	3x97	817	620	80	166
<b>L</b>	2137	105	150	820	1380	560	102 394	633 342	180	75	87 75	60	3x97	817	620	80	133

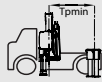

F85B.1 - F165A.2 / F185A.2

3000 mm      3300 mm

4210 daN

3490 daN

F175A.0 - F195A.2

3700 mm      4000 mm

F215A.0 - F235A.2 / F255A.2

4000 mm      4200 mm

F145AS - F160ASXP

3500 mm

F195AS - F210ASXP

4000 mm

F215AS - F240ASXP

4500 mm

### SUPPLEMENTARY OUTRIGGERS

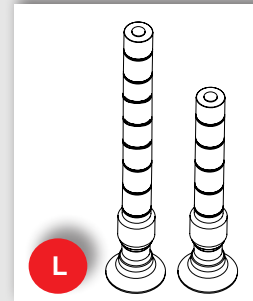
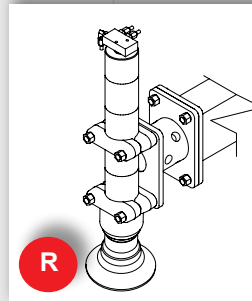
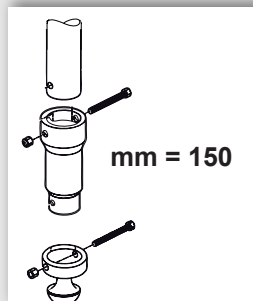
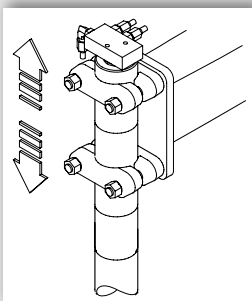

optional

## 215800HE - 215800HE/CE - 215800HS/CE

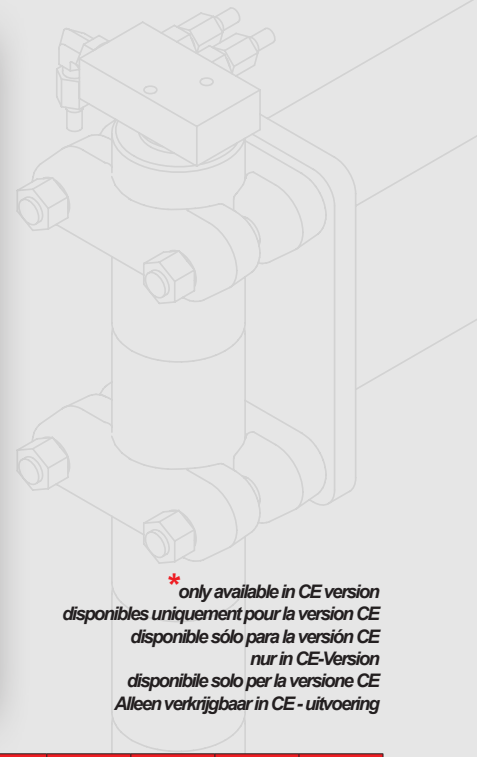
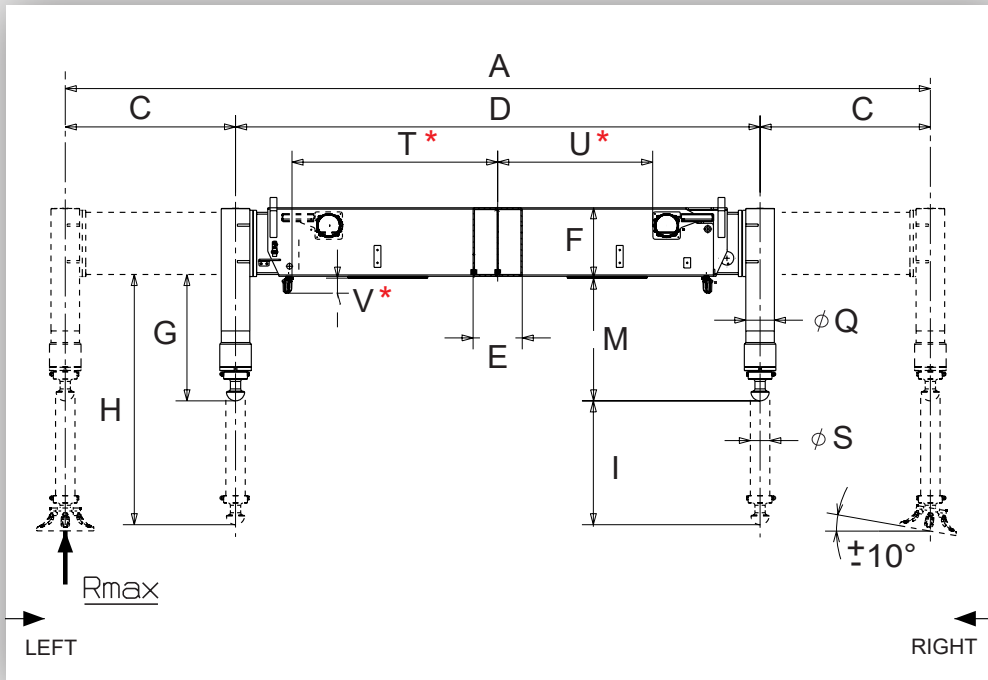

OPTIONS	A	C	D	E	F	G	H	I	M	φ Q	φ S	T*	U*	V*	
	5080	1395	2290	215	308	553	1095	542	537	125	85	900	678	66	530
<b>R</b>	5150	1395	2360	215	308	934	1551	633	918	125	85	900	678	66	580

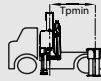

KIT 330K065

F215A.0 - F235A.2 / F255A.2

2000 mm

10000 daN

6 kg

F245A.0 - F275A.2 / F305A.2

2500 mm

F295A.2 / F315A.2 / F345A.2

3000 mm

F295RA.2 / F315RA.2 / F345RA.2

3000 mm

F335A.2 / F365A.2 / F395A.2 - F335RA.2 / F365RA.2 / F395RA.2

3500 mm

F385A.2 / F425A.2 - F385RA / F425RA.2

4000 mm

F415A.2 / F455A.2 / F485A.2 - F415RA.2 / F455RA.2 / F485RA.2

4500 mm



### SUPPLEMENTARY OUTRIGGERS

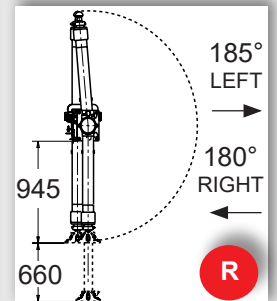
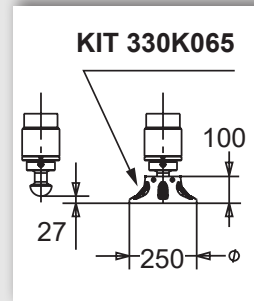
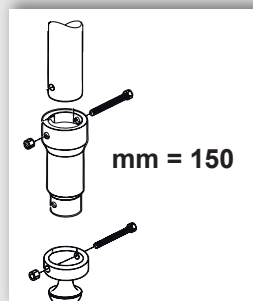
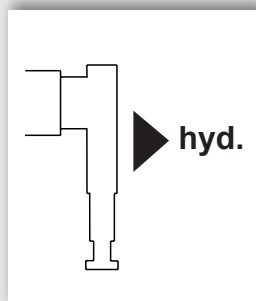
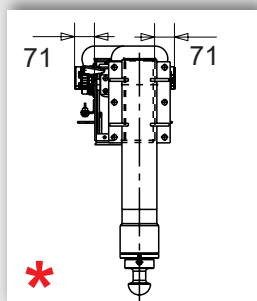

optional

## 290800HE - 290800HE/CE - 290800HS/CE

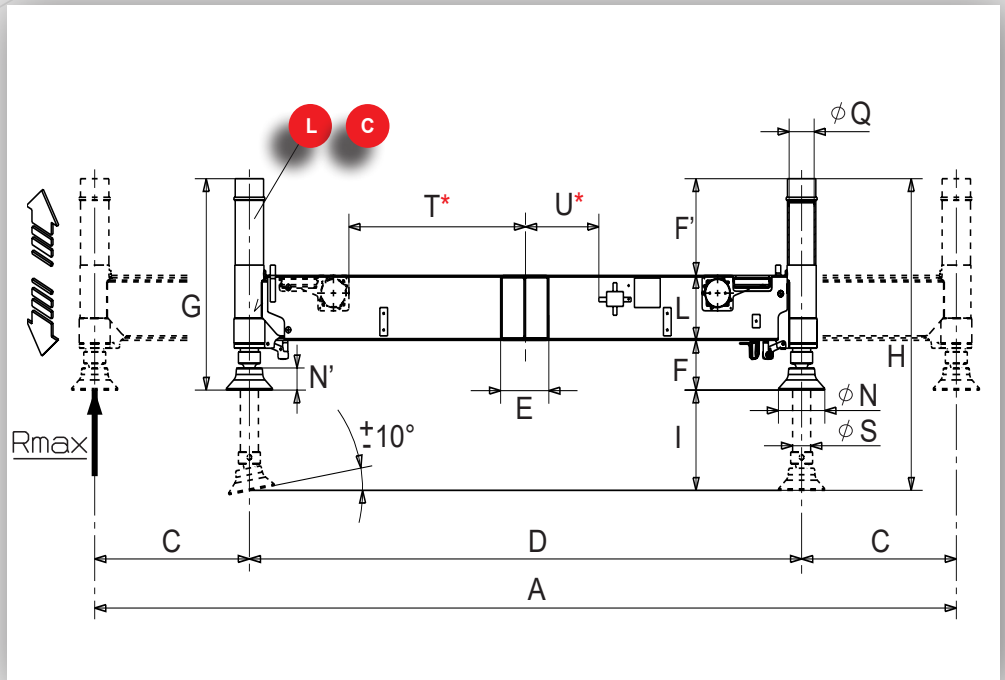

\* only available in CE version  
 disponibles uniquement pour la version CE  
 disponible sólo para la versión CE  
 nur in CE-Version  
 disponibile solo per la versione CE  
 Alleen verkrijgbaar in CE - uitvoering

	A	C	D	E	F'	F	G	H	I	L	φ N	N'	φ Q	φ S	T*	U*	
L	4142	1000	2142	187	108/554	615/169	943	1493	550	220	180	75	97	70	685	284	340
C	4142	1000	2142	187	108/328	389/169	717	1057	340	220	180	75	97	70	685	284	320

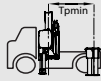

F110B.0 - F135A.2

3000 mm

F155A.0 - F165A.2 / F185A.2

3200 mm

F175A.0 - F175A.2

3500 mm

F195A.0 - F195A.2

3850 mm

F215A.0 / F235A.0

3850 mm

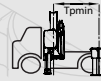

F215A.2 / F235A.2 / F255A.2

4000 mm

F245A.0 / F275A.0

4000 mm

F245A.2 / F275A.2 / F305A.2

4000 mm

F295A.2 / F315A.2 / F345A.2

4200 mm

F295RA.2 / F315RA.2 / F345RA.2

4200 mm



5710 daN

### SUPPLEMENTARY OUTRIGGERS

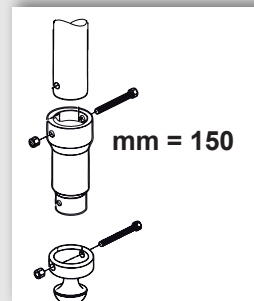
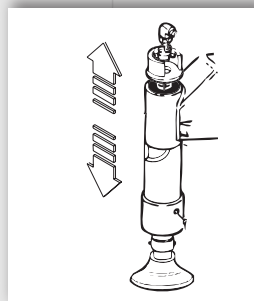
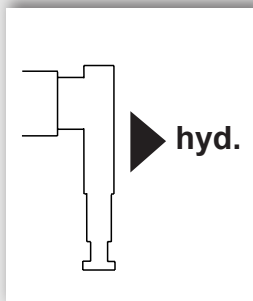
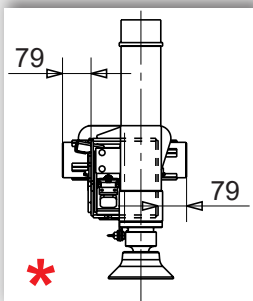

## 330802HE - 330802HE/CE - 330802HS/CE

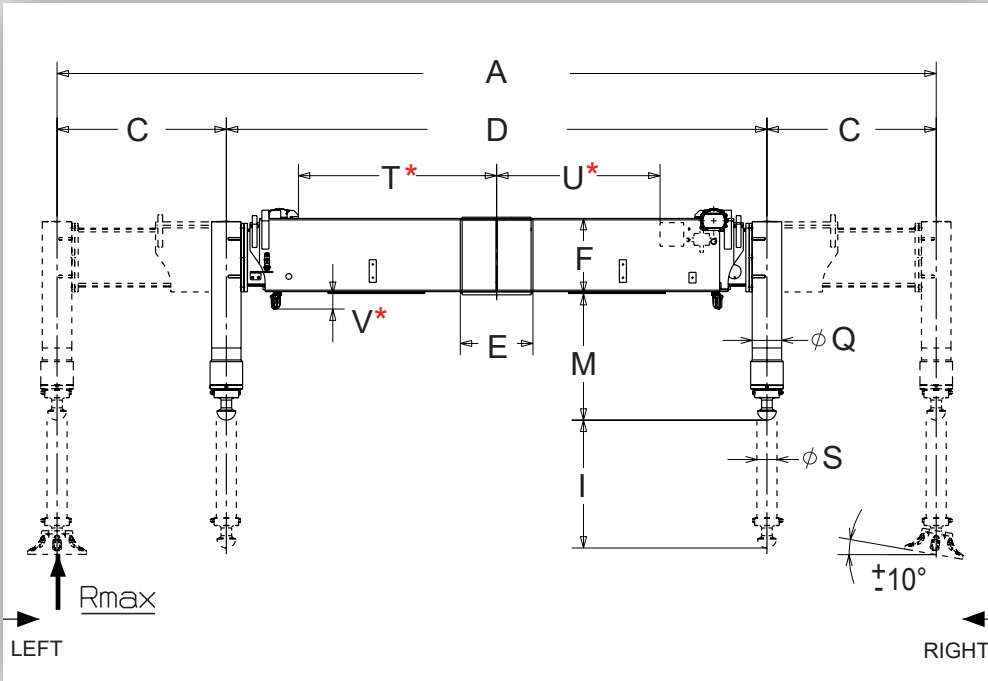

OPTIONS	A	C	D	E	F	I	M	φQ	φS	T*	U*	V*	
	5990	1850	2290	256	318	542	537	125	85	840	690	66	720
<b>R</b>	6060	1850	2360	256	318	633	913	125	85	840	690	66	770



F335A.2 / F365A.2 / F395A.2

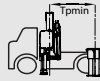

3000 mm

F335RA.2 / F365RA.2 / F395RA.2

3000 mm

F385A / F425A.2 - F385RA / F425RA.2

3000 mm

F415A.2 / F455A.2 / F485A.2 - F415RA.2 / F455RA.2 / F485RA.2

3500 mm

F515RA.2 / F545RA.2

3500 mm



14000 daN

KIT 330K065

6 kg



### SUPPLEMENTARY OUTRIGGERS

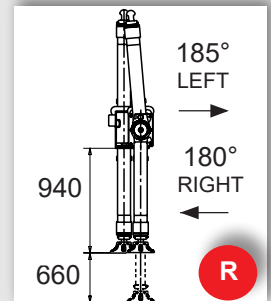
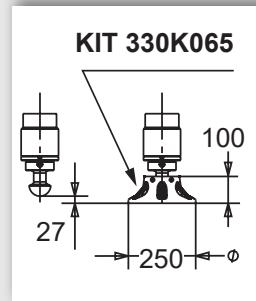
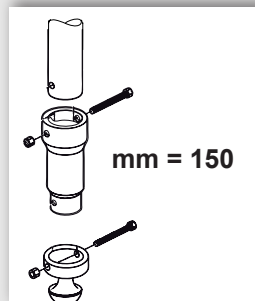
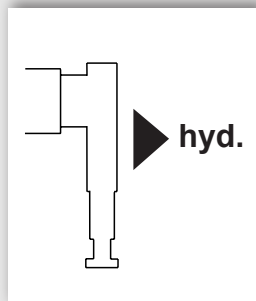
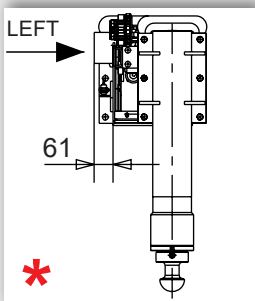

optional

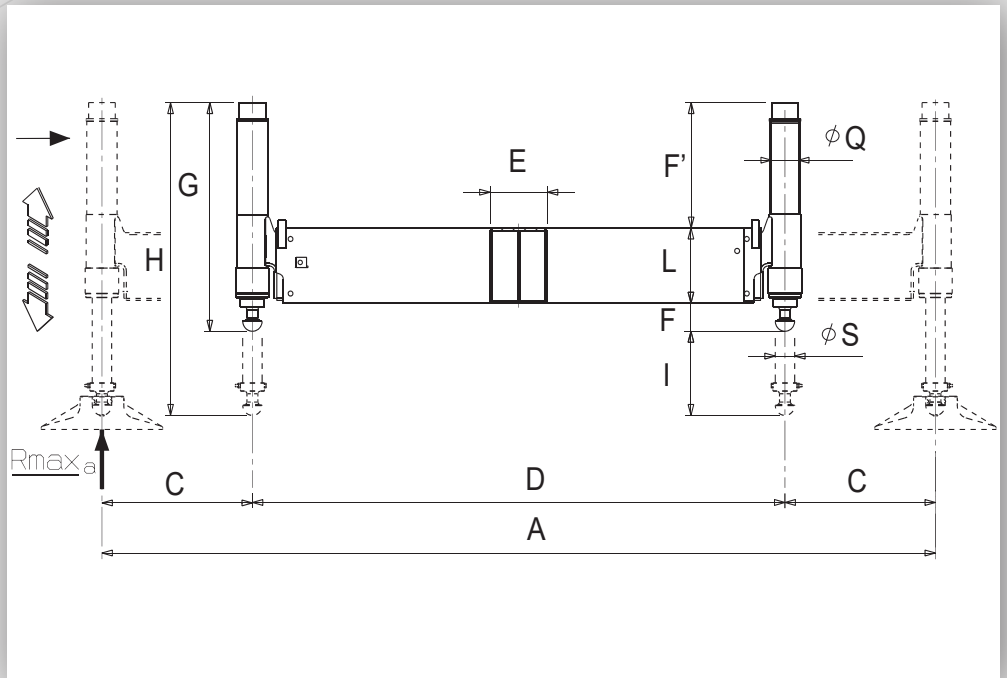

\* only available in CE version  
 disponibles uniquement pour la version CE  
 disponible sólo para la versión CE  
 nur in CE-Version  
 disponibile solo per la versione CE  
 Alleen verkrijgbaar in CE - uitvoering

A	C	D	E	F'	F	G	H	I	L	φQ	φS	
4984	1395	2194	236	127/493	475/109	897	1407	510	295	112	80	575



F390SE

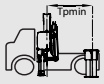

3500 mm

KIT 330K064

14 kg

### SUPPLEMENTARY OUTRIGGERS

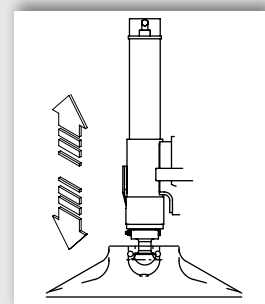
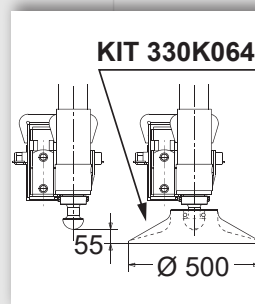
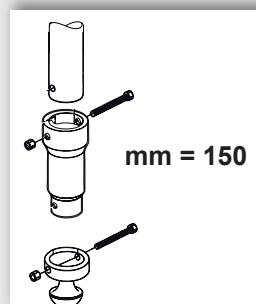
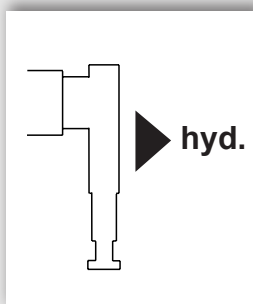

## 415800HE - 415800HE/CE - 415800HS/CE

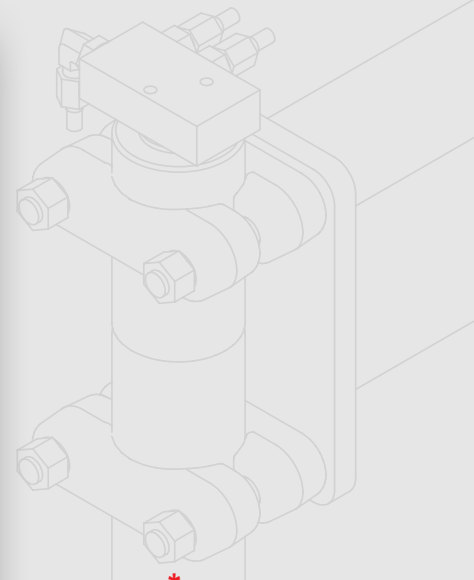
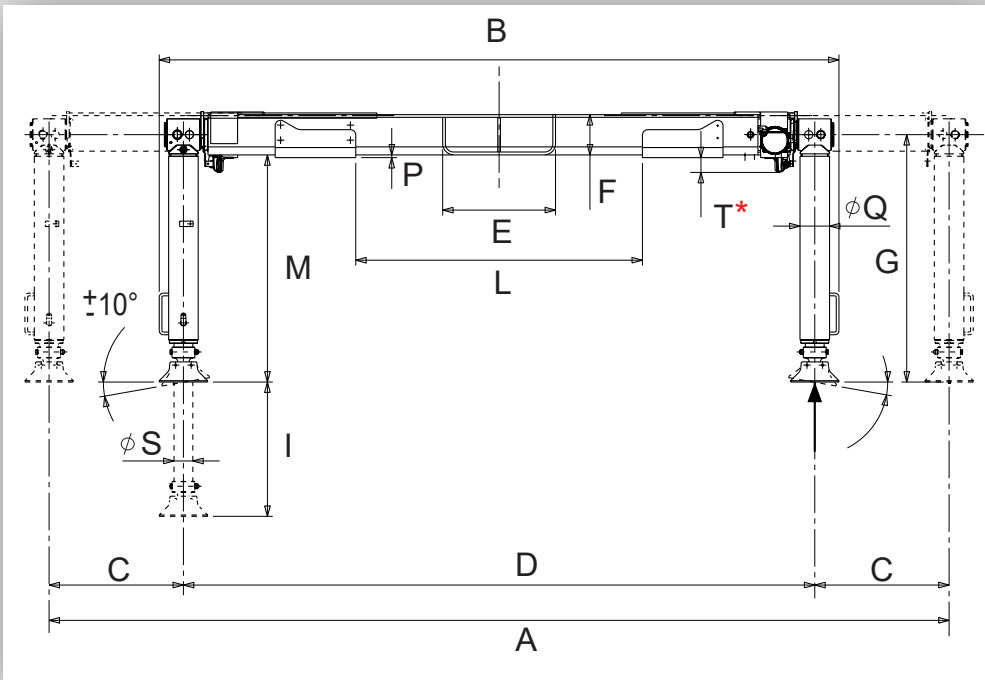

\* only available in CE version  
 disponibles uniquement pour la version CE  
 disponible sólo para la versión CE  
 nur in CE-Version  
 disponibile solo per la versione CE  
 Alleen verkrijgbaar in CE - uitvoering

	A	B	C	D	E	F	G	I	L	M	P	φ Q	φ S	T*	
	5450	2530	1550	2350	420	150	920	550	1067	847	10	110	70	55	660
<b>C</b>	5450	2530	1550	2350	420	150	780	410	1067	707	10	110	70	55	645

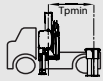

F215A.0 - F275A.2 / F305A.2      5000 mm

R<sub>max</sub>      9000 daN

F295A.2 - F365RA.2 / F395RA.2      5500 mm

F385A.2 - F485RA.2      6000 mm



### SUPPLEMENTARY OUTRIGGERS

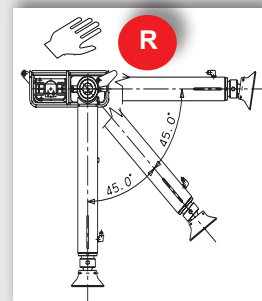
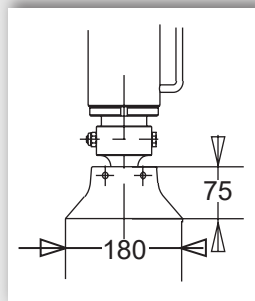
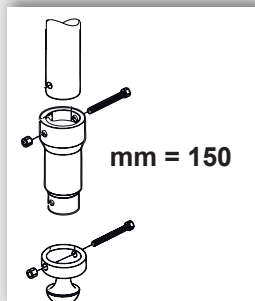
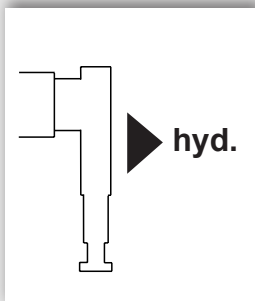



## 415802HE - 415802HE/CE - 415802HS/CE

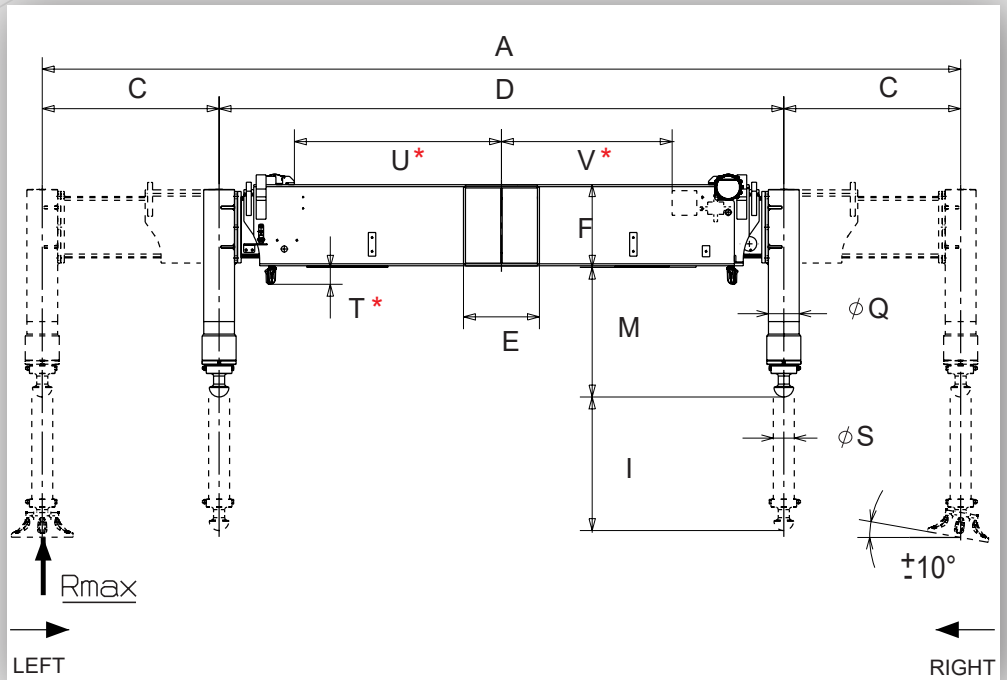

\* only available in CE version  
 disponibles uniquement pour la version CE  
 disponible sólo para la versión CE  
 nur in CE-Version  
 disponibile solo per la versione CE  
 Alleen verkrijgbaar in CE - uitvoering

OPTIONAL	A	C	D	E	F	I	M	φ Q	φ S	T*	U*	V*	
	7210	2460	2290	308	335	542	527	125	85	69	840	690	970
<b>R</b>	7280	2460	2360	308	335	648	910	125	85	69	840	690	1040

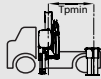

KIT 330K065

F385A.2 / F425A.2

3000 mm

16850 daN

6 kg

F385RA.2 / F425RA.2

3000 mm

F415A.2 / F455A.2 / F485A.2

3500 mm

F415RA.2 / F455RA.2 / F485RA.2

3500 mm

F515RA.2 / F545RA.2

3500 mm

F600RA.2 / F660RA.2 / F710RA.2

4500 mm

### SUPPLEMENTARY OUTRIGGERS

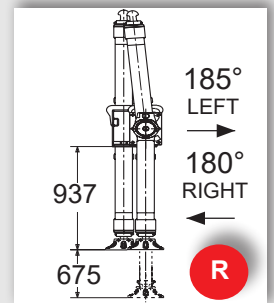
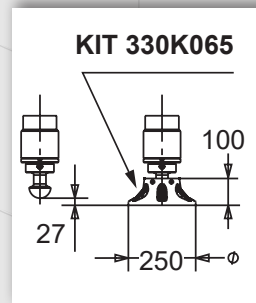
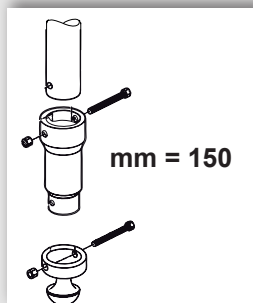
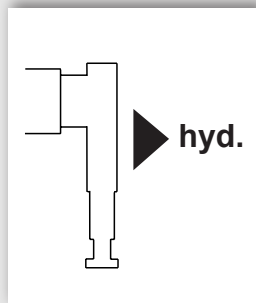
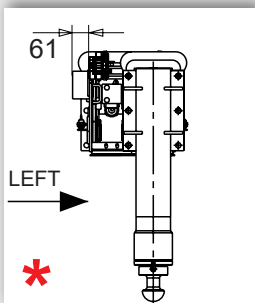

optional

## 541800HE - 541800HE/CE - 541800HS/CE

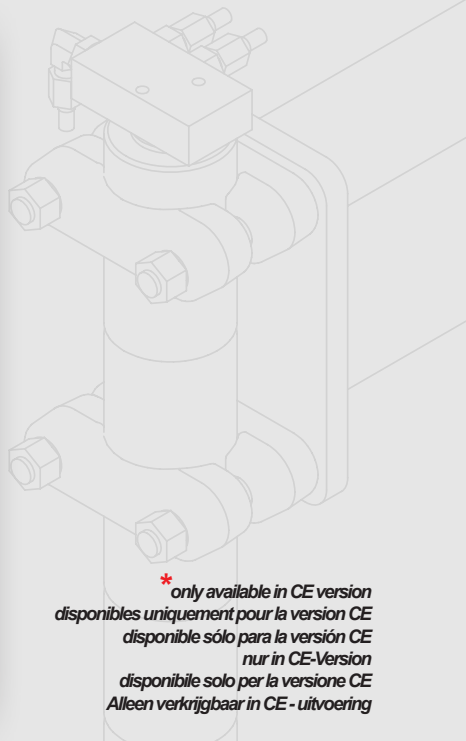
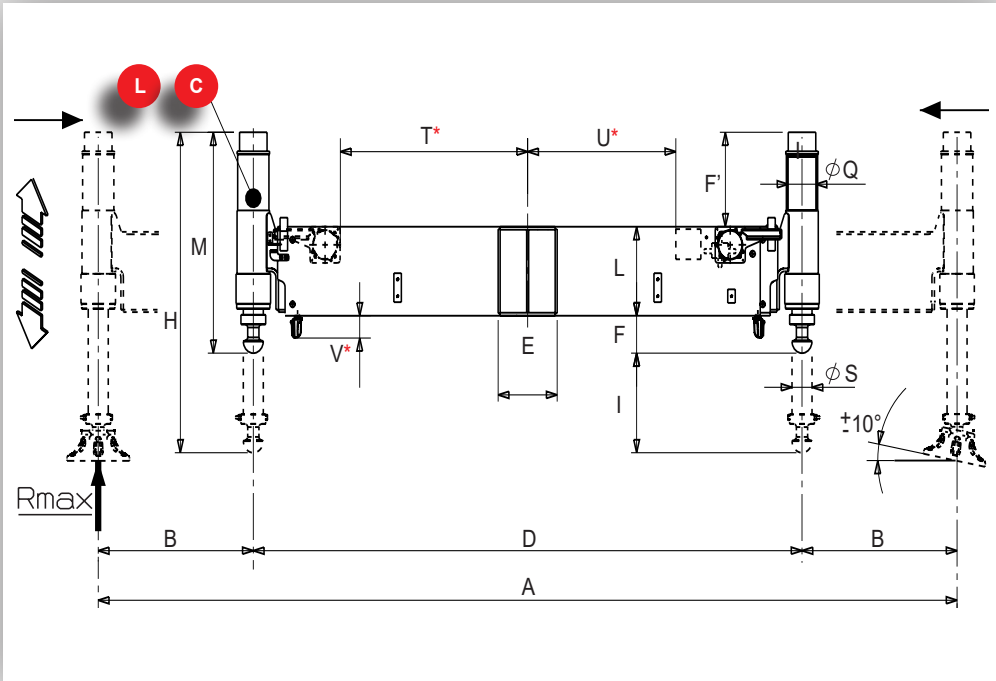

	A	B	D	E	F'	F	H	I	L	M	φ Q	φ S	T*	U*	V*	
L	4984	1395	2194	236	127/493	475/109	1407	510	295	897	112	80	750	595	74	570
C	4984	1395	2194	236	127/313	310/124	1062	330	295	732	112	80	750	595	74	555

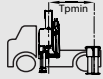

KIT 330K065

F335A.2 / F365A.2 / F395A.2      3500 mm

13040 daN

6 kg

F335RA.2 / F365RA.2 / F395RA.2      3500 mm

F385A.2 / F425A.2      3850 mm

F385RA.2 / F425RA.2      3850 mm

F415A.2 / F455A.2 / F485A.2      4000 mm

F415RA.2 / F455RA.2 / F485RA.2      4000 mm

F515RA.2 / F545RA.2      4000 mm

F600RA.2 / F660RA.2 / F710RA.2      5800 mm



### SUPPLEMENTARY OUTRIGGERS

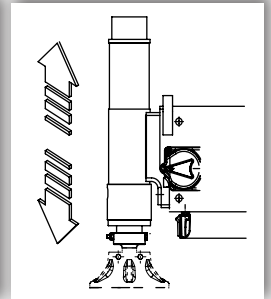
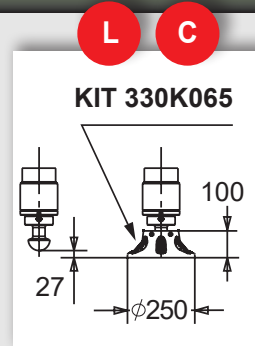
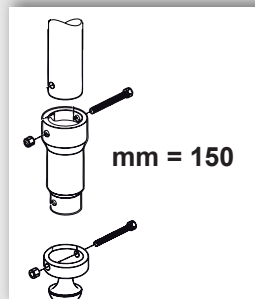
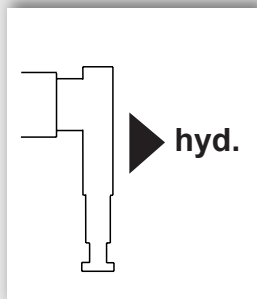
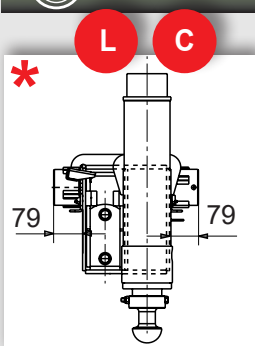

## 700802HE - 700802HE/CE - 700802HS/CE

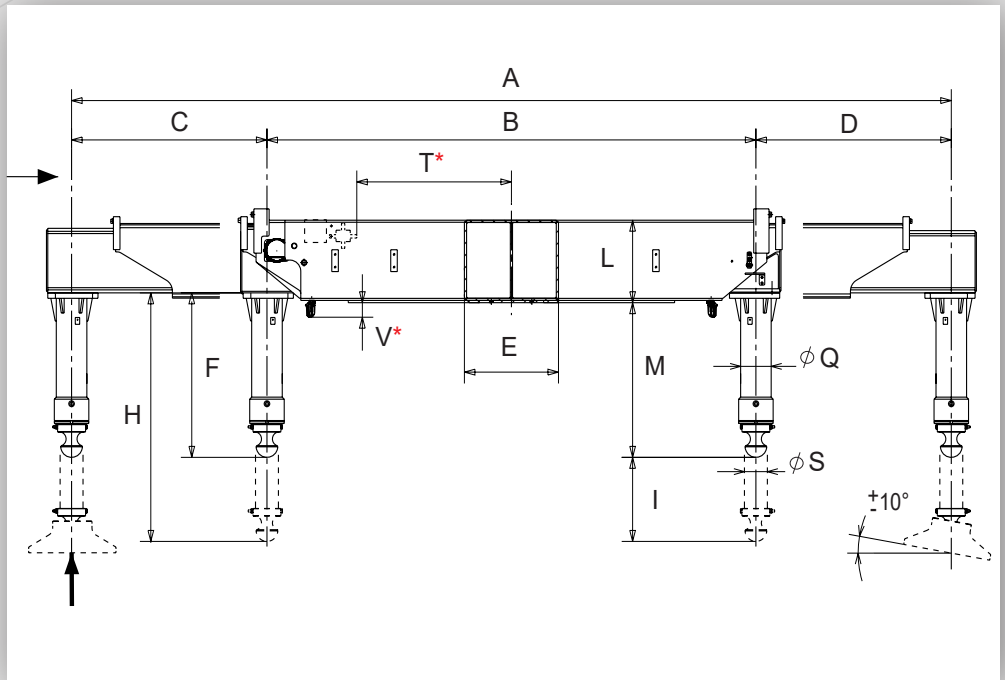

\* only available in CE version  
 disponibles uniquement pour la version CE  
 disponible sólo para la versión CE  
 nur in CE-Version  
 disponibile solo per la versione CE  
 Alleen verkrijgbaar in CE - uitvoering

	A	B	C	D	E	F	H	I	L	M	φQ	φS	T*	V*	
<b>L</b>	8290	2240	3100	2950	431	875	1395	520	363	830	140	105	709	64	1495
<b>C</b>	8290	2240	3100	2950	431	725	1095	370	363	680	140	105	709	64	1475

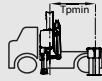

KIT 330K062

F600RA.2 / F660RA.2 / F710RA.2      3000 mm

24500 daN

16 kg

F720RA.2 / F800RA.2 / F820RA.2      3500 mm

F950RA.2 / F990RA.2      4000 mm

F1150RA.2      4500 mm

### SUPPLEMENTARY OUTRIGGERS

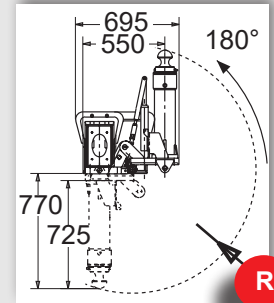
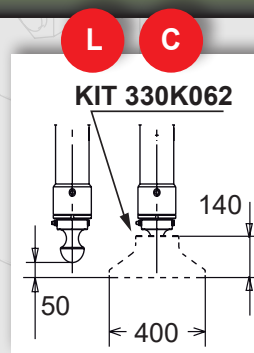
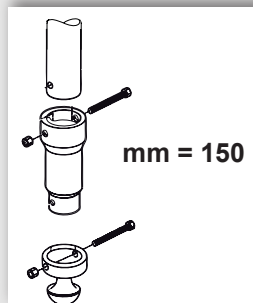
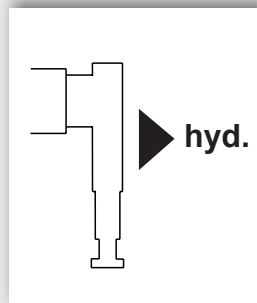
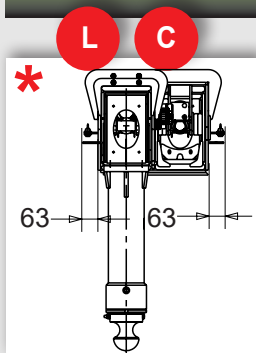

optional

## 752801HE - 752801HE/CE - 752801HS/CE

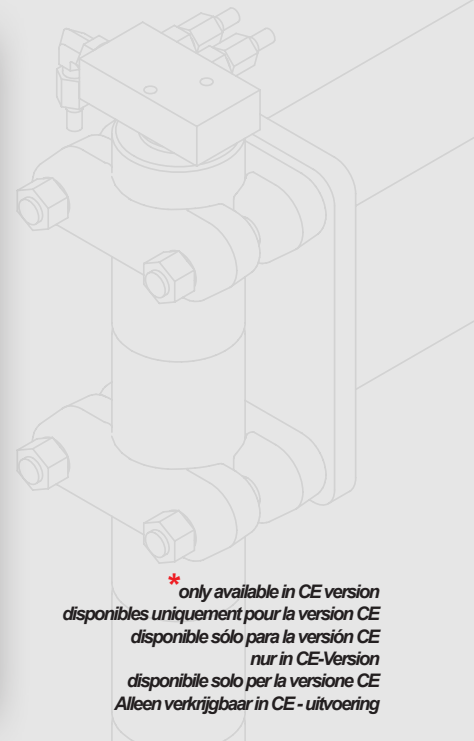
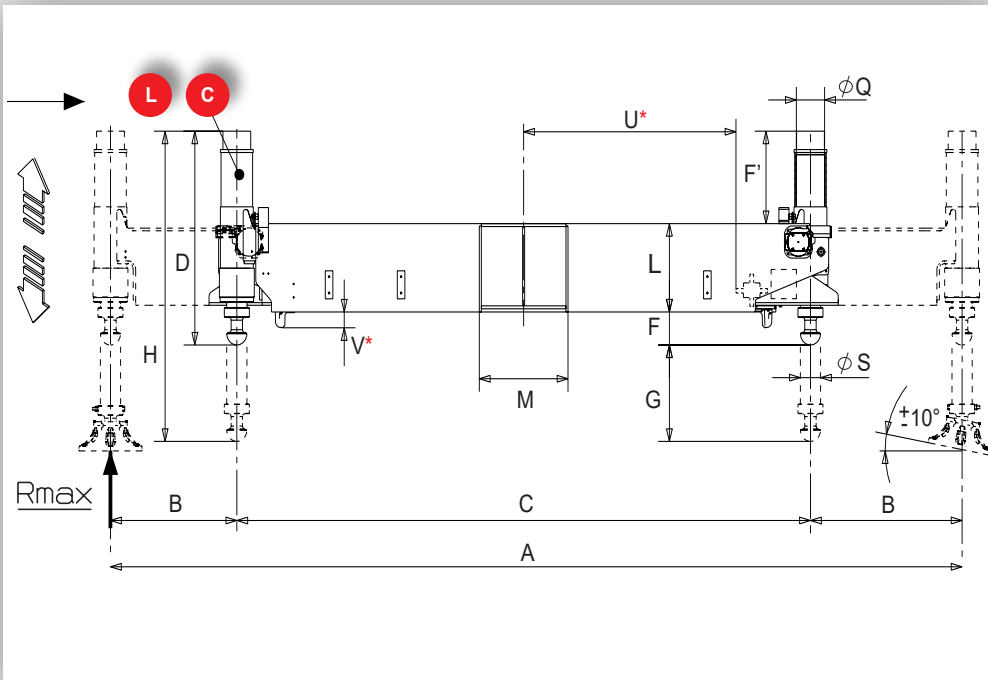

	A	B	C	D	F'	F	G	H	L	M	φ Q	φ S	T*	U*	V*	
L	5770	1750	2270	897	131/497	542/176	510	1407	303	351	112	80	965	840	54	805
C	5770	1750	2270	732	131/317	299/113	330	1062	303	351	112	80	965	840	54	795



F720RA.2 / F800RA.2 / F820RA.2

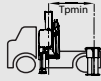

4500 mm



16220 daN

KIT 330K065

6 kg



### SUPPLEMENTARY OUTRIGGERS

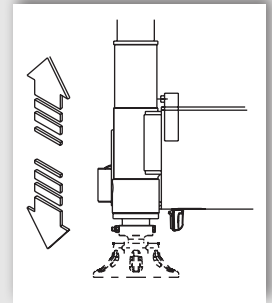
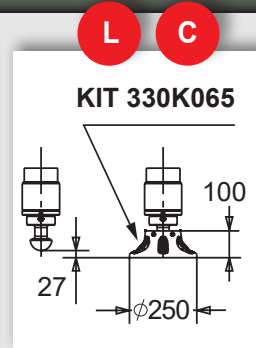
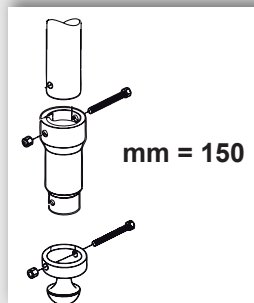
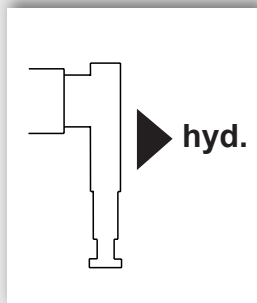
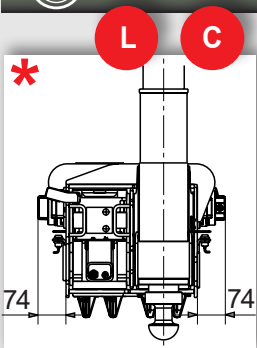

## 752802HE - 752802HE/CE - 752802HS/CE

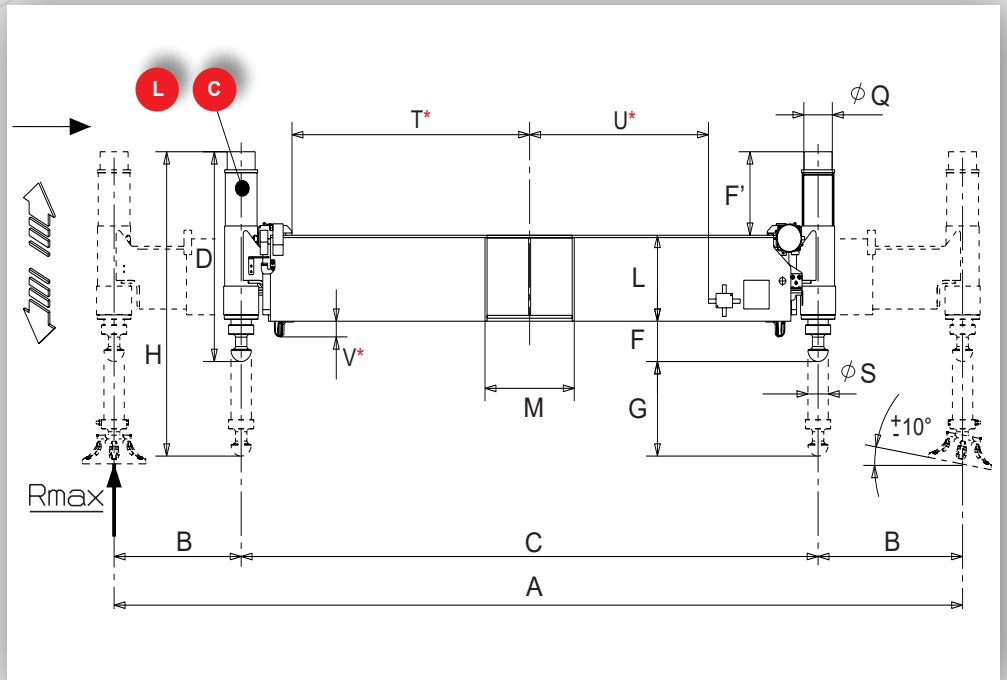

\* only available in CE version  
 disponibles uniquement pour la version CE  
 disponible sólo para la versión CE  
 nur in CE-Version  
 disponibile solo per la versione CE  
 Alleen verkrijgbaar in CE - uitvoering

	A	B	C	D	F'	F	G	H	L	M	$\phi Q$	$\phi S$	T*	U*	V*	
<b>L</b>	6870	2300	2270	897	106/472	508/142	510	1407	300	351	112	80	935	705	55	920
<b>C</b>	6870	2300	2270	732	106/292	328/142	330	1062	300	351	112	80	935	705	55	910

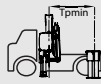

F720RA.2 / F800RA.2 / F820RA.2      5000 mm



14070 daN

KIT 330K065

6 kg

### SUPPLEMENTARY OUTRIGGERS

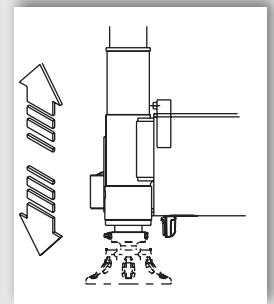
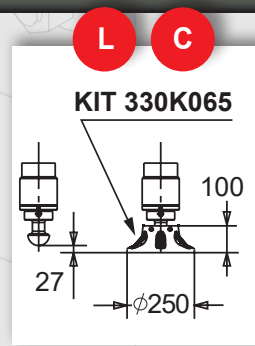
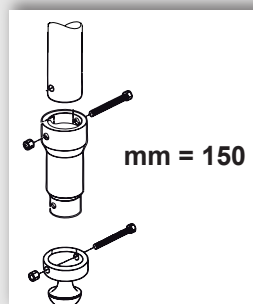
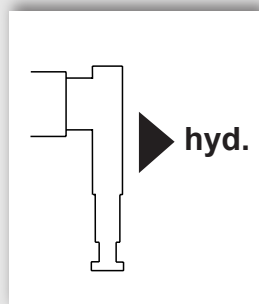
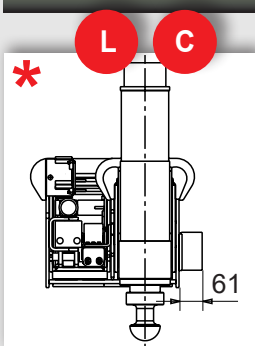

## 1150A140 - 1150A140/CE - 1150A140S/CE

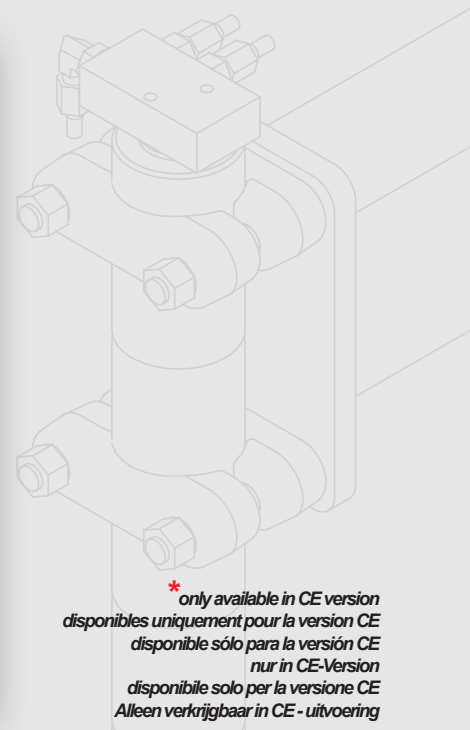
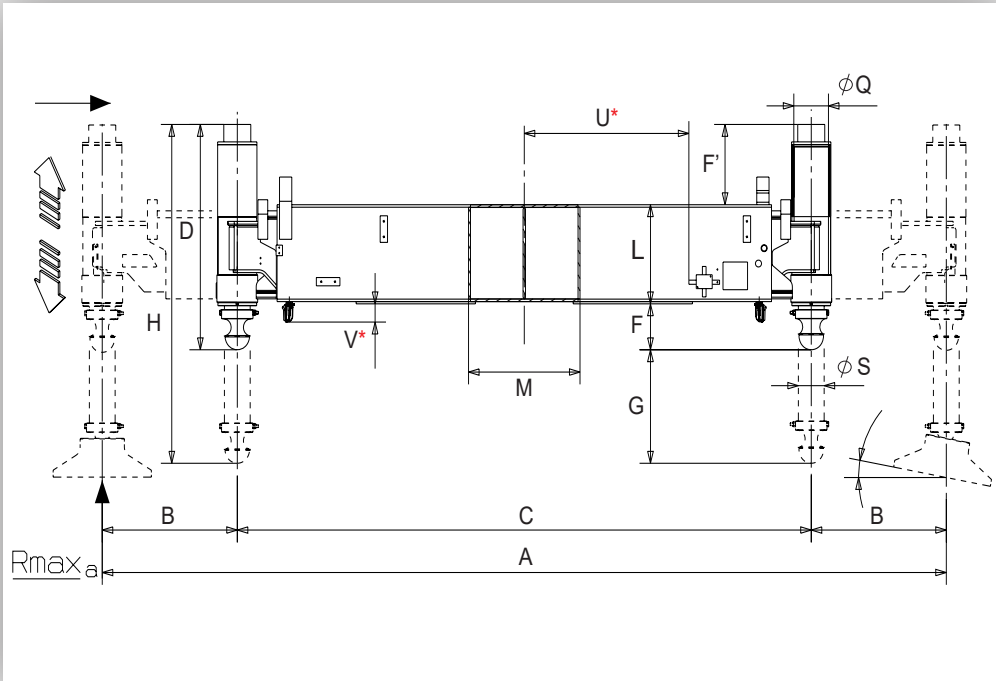

\* only available in CE version  
 disponibles uniquement pour la version CE  
 disponible sólo para la versión CE  
 nur in CE-Version  
 disponibile solo per la versione CE  
 Alleen verkrijgbaar in CE - uitvoering

A	B	C	D	F	F'	G	H	L	M	φQ	φS	U*	V*	
7538	2600	2338	815	427/167	30/290	410	1225	358	454	140	105	670	65	1350

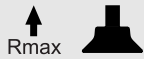
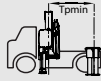

KIT 330K062

F950RA.2 / F990RA.2

3000 mm

21000 daN

16 kg

F1150RA.2

4000 mm

F1300RA.2 / F1350RA.2

4500 mm

F1600RA.2 / F1650RA.2

6000 mm



### SUPPLEMENTARY OUTRIGGERS

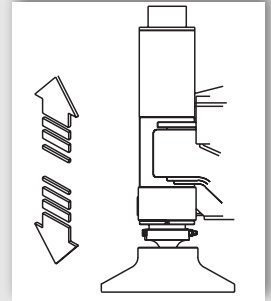
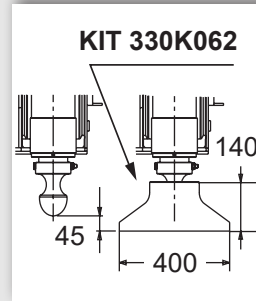
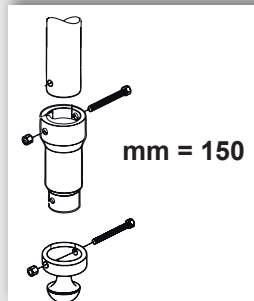
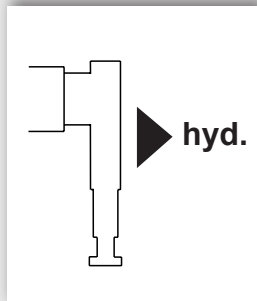
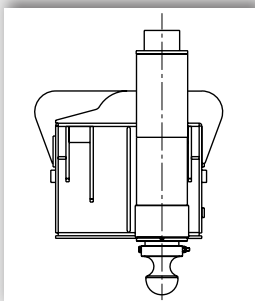

## 1400A140 - 1400A140/CE- 1400A140S/CE

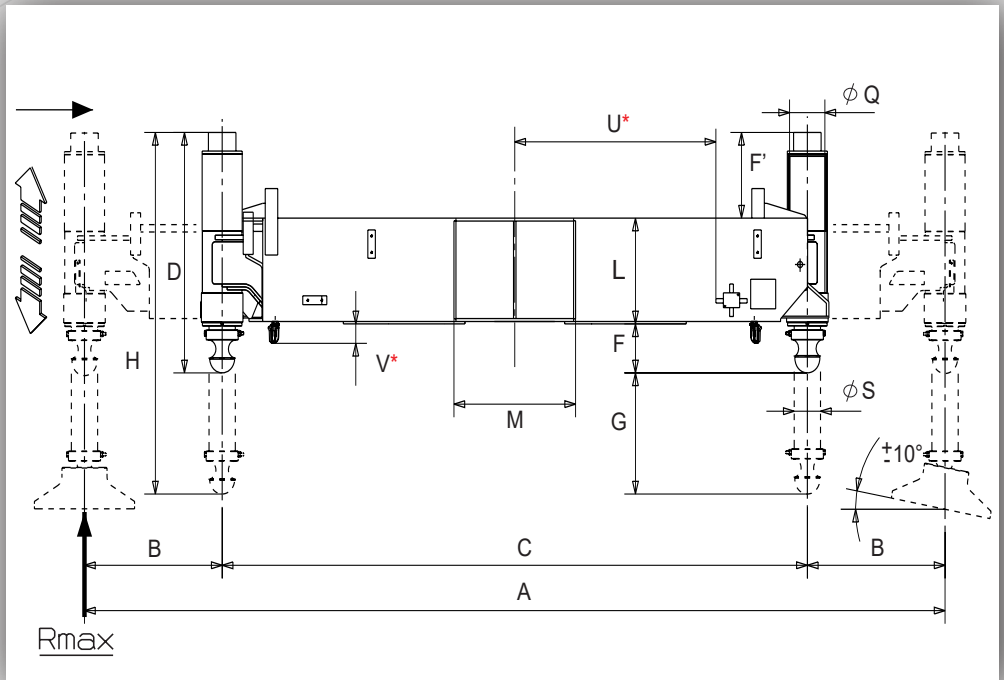

\* only available in CE version  
 disponibles uniquement pour la version CE  
 disponible sólo para la versión CE  
 nur in CE-Version  
 disponibile solo per la versione CE  
 Alleen verkrijgbaar in CE - uitvoering

A	B	C	D	F	F'	G	H	L	M	$\phi Q$	$\phi S$	U*	V*	
8538	3100	2338	815	427/167	30/290	410	1225	358	485	140	105	805	65	1650

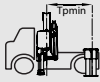

KIT 330K062

F950RA.2 / F990RA.2 3500 mm

18480 daN

16 kg

F1150RA.2 4500 mm

F1300RA.2 / F1350RA.2 5000 mm

### SUPPLEMENTARY OUTRIGGERS

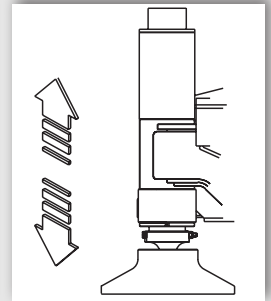
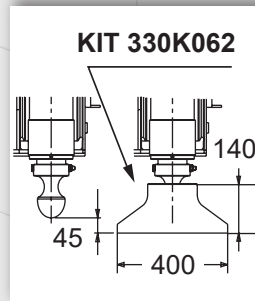
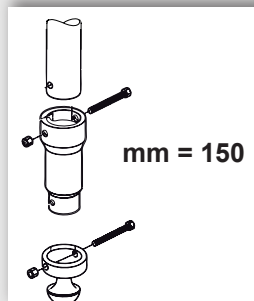
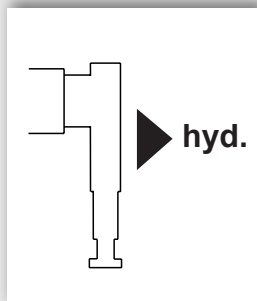
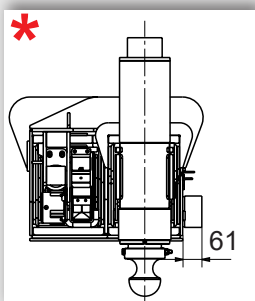

## 1400A203 - 1400A203/CE

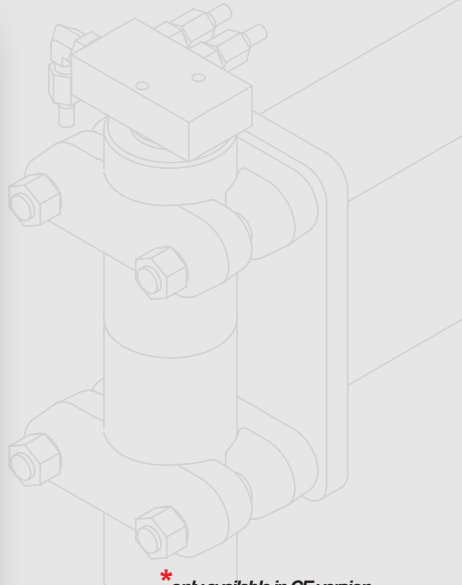
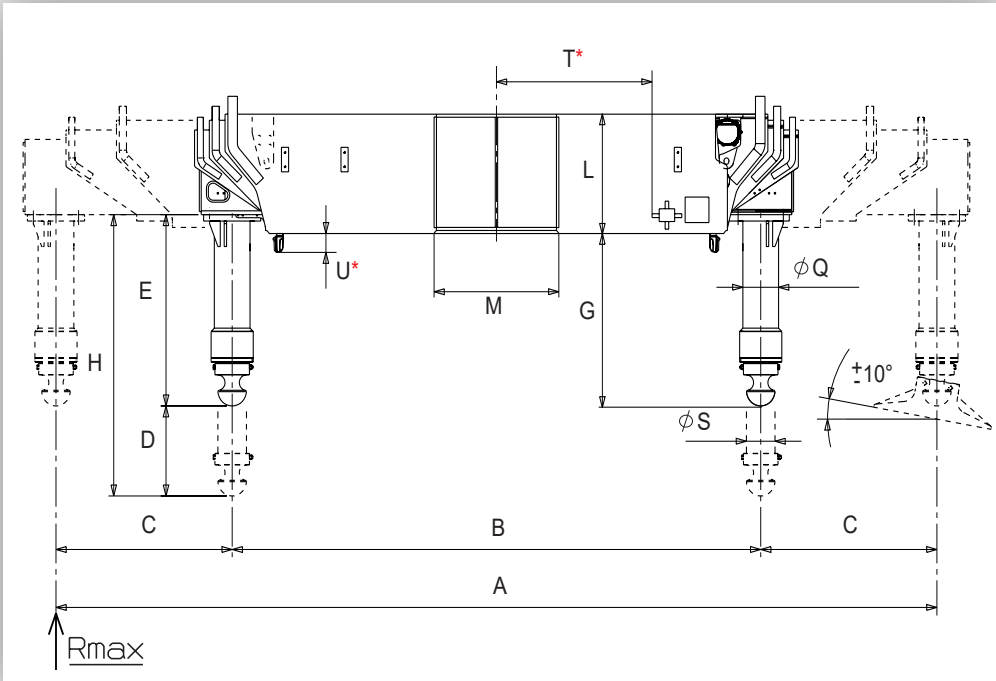

\* only available in CE version  
 disponibles uniquement pour la version CE  
 disponible sólo para la versión CE  
 nur in CE-Version  
 disponibile solo per la versione CE  
 Alleen verkrijgbaar in CE - uitvoering

A	B	C	D	E	G	H	L	M	$\phi Q$	$\phi S$	T*	U*	
9960	2220	3870	353	750	676	1103	468	524	150	120	654	74	2450

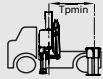

KIT 330K033

F1950RA.2 / F2150RA.2

4400 mm

36500 daN

17 kg

F1950RAL.2 / 2150RAL.2

4400 mm



### SUPPLEMENTARY OUTRIGGERS

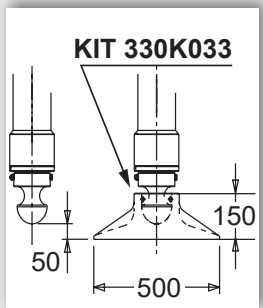
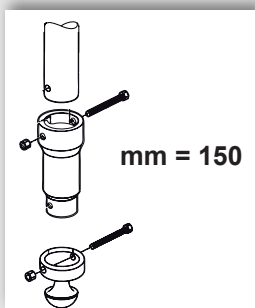
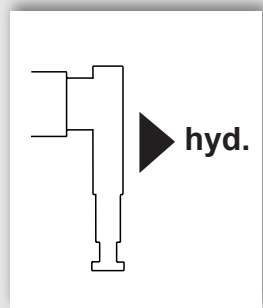
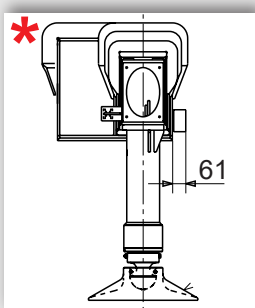



## 1400A303 - 1400A303/CE

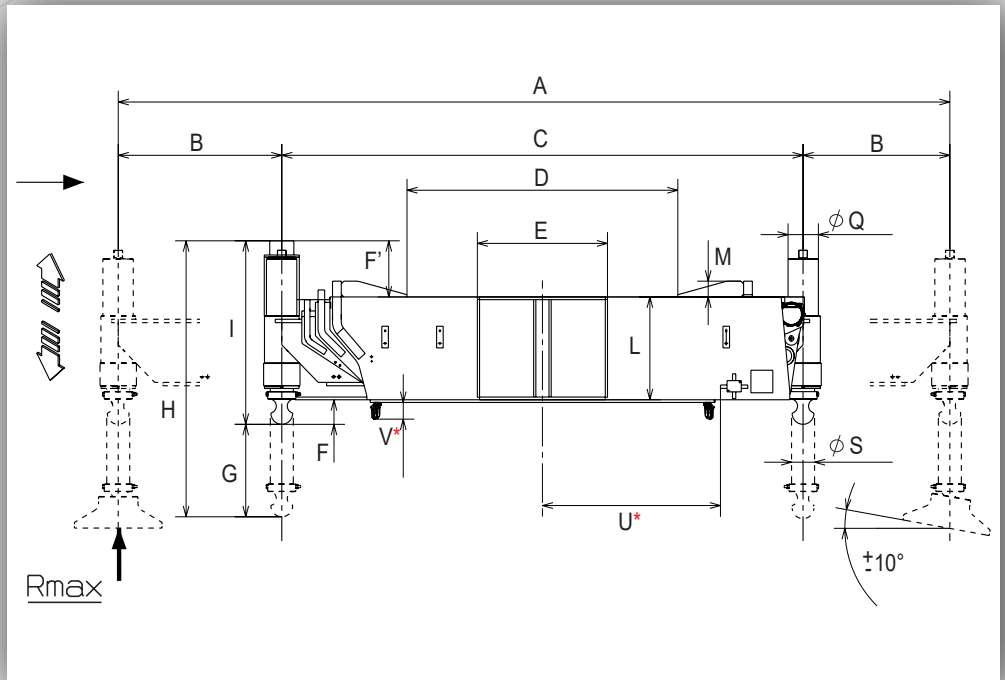

\* only available in CE version  
 disponibles uniquement pour la version CE  
 disponible sólo para la versión CE  
 nur in CE-Version  
 disponibile solo per la versione CE  
 Alleen verkrijgbaar in CE - uitvoering

A	B	C	D	E	F	F'	G	H	I	L	M	φQ	φS	U*	V*	
10120	3870	2380	1236	594	109/362	249/-4	410	1224	814	456	70	140	105	815	74	2420



F1950RA.2 / F2150RA.2      4400 mm

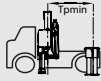

F1950RAL.2 / F2150RAL.2      4400 mm



36500 daN

KIT 330K062

16 kg

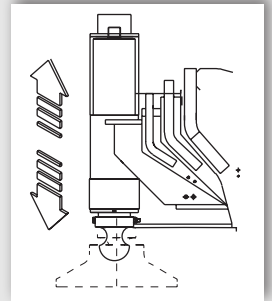
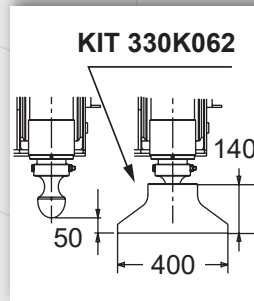
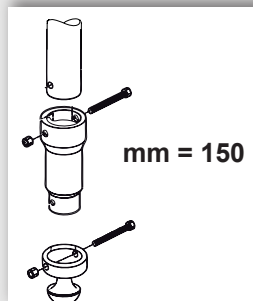
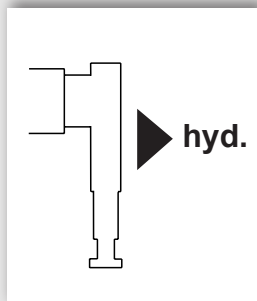
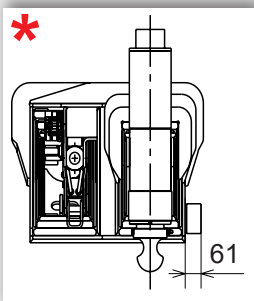

### SUPPLEMENTARY OUTRIGGERS

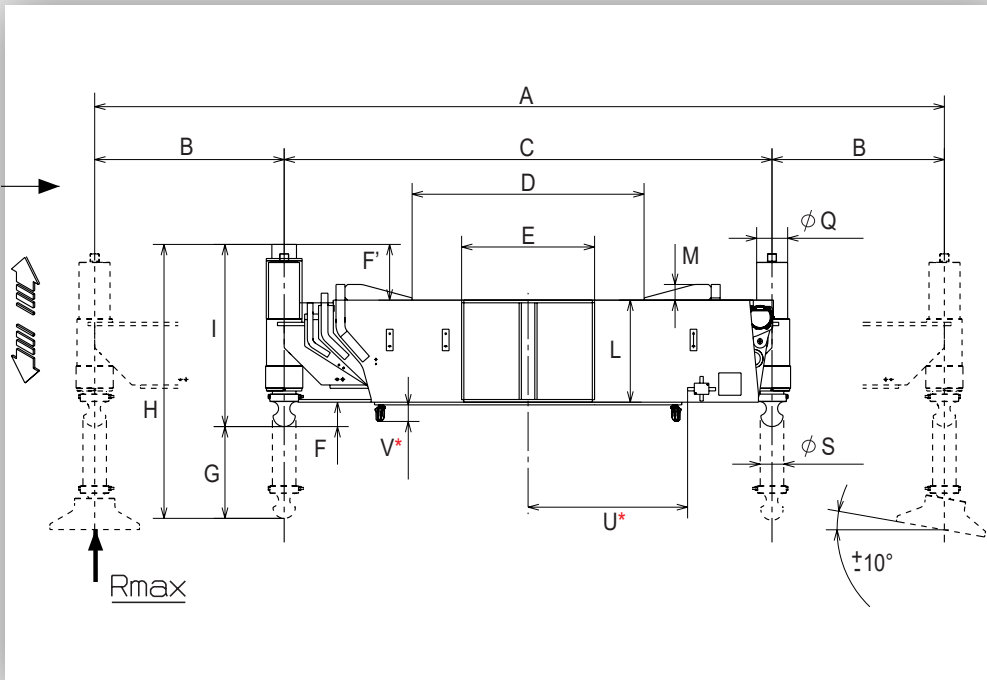

## 1400A313 - 1400A313/CE



A	B	C	D	E	F	F'	G	H	I	L	M	φQ	φS	U*	V*	
9170	3495	2180	1036	594	109/362	249/-4	410	1224	814	456	70	140	105	715	74	2200

			<b>KIT 330K062</b>
F1600RA.2 / F1650RA.2	3900 mm	36500 daN	16 kg
F1600RAL.2 / F1650RAL.2	3900 mm		
F1950RA.2 / F2150RA.2	4400 mm		
F1950RAL.2 / F2150RAL.2	4400 mm		

### SUPPLEMENTARY OUTRIGGERS

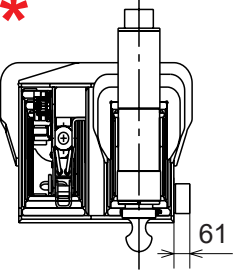
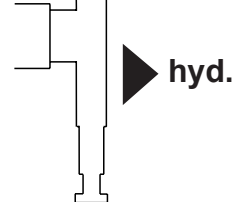
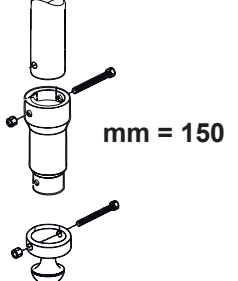
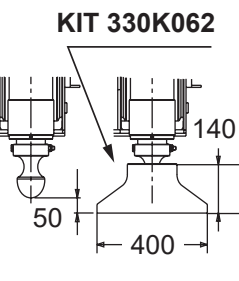
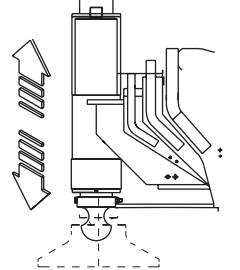
				
---	---	---	--	---

## 1950A203 - 1950A203/CE

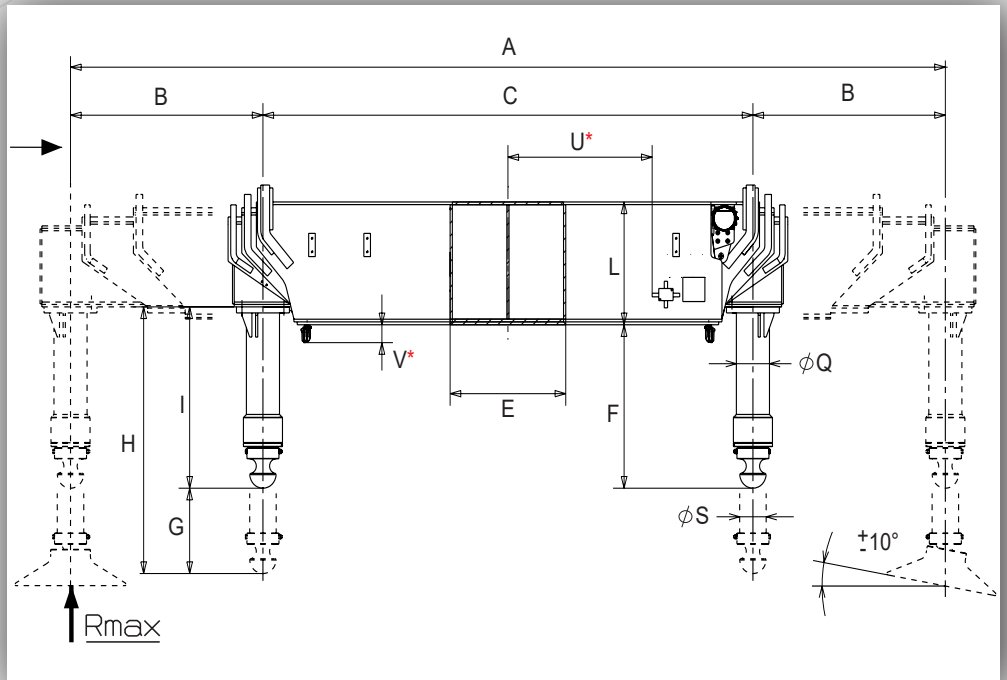

\* only available in CE version  
 disponibles uniquement pour la version CE  
 disponible sólo para la versión CE  
 nur in CE-Version  
 disponibile solo per la versione CE  
 Alleen verkrijgbaar in CE - uitvoering

A	B	C	E	F	G	H	I	L	φQ	φS	U*	V*	
10690	4235	2220	524	676	353	1103	750	508	150	120	654	74	2500



F1950RA.2 / F2150RA.2      2000 mm

F1950RAL.2 / F2150RAL.2      2000 mm



36500 daN

KIT 330K033

17 kg

### SUPPLEMENTARY OUTRIGGERS

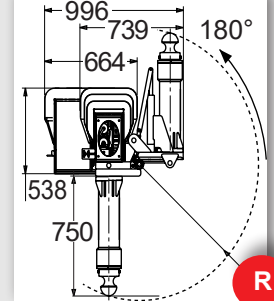
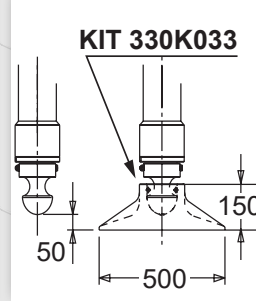
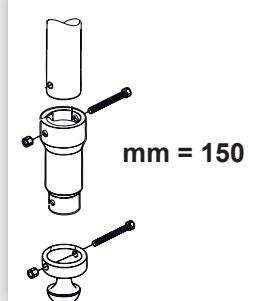
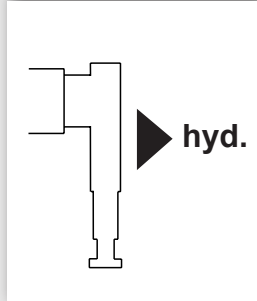
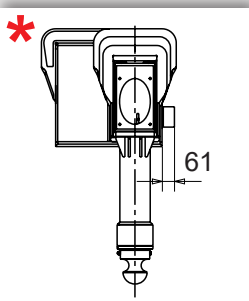

optional

**R** 854



	Reazione massima traversa standard	Maximum reaction of supplementary outrigger	Réaction maximum traverse supplémentaire standard	Höchste Reaktion vom standard Abstützträger	Reacción máxima estabilizador suplementario	Maximale reactiekraft van de standaard afstempelbalk
	Reazione massima traversa con martinetto rotante	Maximum reaction of supplementary outrigger with tiltable ram	Réaction maximum traverse supplémentaire avec vérin pivotant	Höchste Reaktion vom standard Abstützträger mit schwenkbarer Abstützung	Reacción máxima estabilizador suplementario con cilindro orientable	Maximale reactiekraft van de afstempelbalk voorzien van opzwenkbare steunpootcilinders
	Distanza minima tra centro colonna e traversa supplementare	Minimum distance between crane column center and supplementary outrigger	Distance minimum entre le centre colonne grue et la traverse supplémentaire	Minderabstand Kransäule – Zusatzabstützträger	Distancia minima centro columna de la grúa y centro estabilizador suplementario	Minimale afstand tussen de hartlijn van de kraan en de afstempelbalk
	Distanza minima tra centro colonna e traversa supplementare con martinetto rotante	Minimum distance between crane column center and supplementary outrigger with tiltable ram	Distance minimum entre le centre colonne grue et la traverse supplémentaire avec vérin pivotant	Minderabstand Kransäule – Zusatzabstützträger bei Hochschwenkstützbeinen	Distancia minima centro columna de la grúa y centro estabilizador suplementario con cilindro orientable	Minimale afstand tussen de hartlijn van de kraan en de afstempelbalk voorzien van opzwenkbare steunpootcilinders
	Peso traversa supplementare	Weight of supplementary outrigger	Poids traverse supplémentaire	Gewicht zusätzlicher Abstützträger	Peso estabilizador suplementario	Eigen gewicht van de afstempelbalk
	Modello Gru	Crane model	Modèle grue	Kranmodell	Modelo grúa	Kraanmodel
	Estensione Manuale	Manual extension	Extension Manuelle	Manuelle Verlängerung	Extensión manual	Handmatig uitschuifbaar
	Estensione Idraulica	Hydraulic extension	Extension hydraulique	Hydraulische Verlängerung	Extensión hidráulica	Hydraulisch uitschuifbaar
	Rotante	Tiltable	Pivotant	Schwenkbar	Orientable	Opzwenkbaar
	Lungo	Long	Long	Lang	Largo	Lang
	Corto	Short	Court	Kurz	Corto	Kort

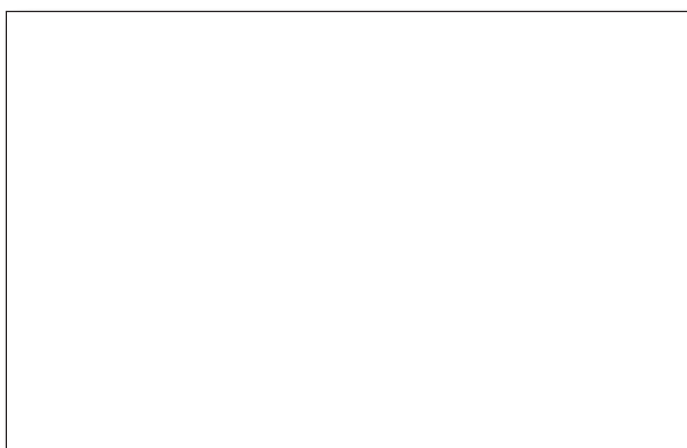

www.fassi.com

FASSI GRU S.p.A.  
Via Roma, 110  
24021 Albino (Bergamo) ITALY  
Tel- +39 035 776400  
Fax +39 035 755020  
http://www.fassi.com  
E-mail: fassi@fassi.com

COMPANY WITH  
QUALITY SYSTEM  
CERTIFIED BY DNV GL  
= ISO 9001 =